

POLARIS SPORTSMAN



2025

**ACCESSORIES,
MAINTENANCE & APPAREL**

INTERNATIONAL VERSION

FORGE YOUR OWN PATH

The ATV that defined the industry, Sportsman combines legendary smoothness, unstoppable versatility and an ease of use that the competition continues to chase, which is why Sportsman is chosen by more ATV owners. Whether you're tearing up the trails, working out in the fields, or navigating the wilderness for the perfect hunt, there is a Sportsman story to be told.

POLARIS
SPORTSMAN

10 450 / 570

- 12 WINCHES, RACKS & PROTECTION
- 14 COMFORT, AUDIO & STORAGE
- 16 WINDSHIELDS
- 18 570 X2, 570 6x6 & TOURING 570
- 24 MAINTENANCE PARTS & FLUIDS

26 850 / XP 1000 / XP 1000 S

- 28 WINCHES & WINDSHIELDS
- 29 RACKS & PROTECTION
- 30 STORAGE, AUDIO & COMFORT
- 32 MAINTENANCE PARTS & FLUIDS

34 SCRAMBLER 850 / XP 1000 S

38 MISCELLANEOUS & YOUTH

40 COMMON ACCESSORIES

- 40 WINCHES
- 42 PLOWS
- 44 TRACKS
- 46 LIGHTING
- 48 CONNECTED TECHNOLOGY
- 50 HUNT
- 52 COOLERS
- 54 WHEELS & TIRES
- 60 TIRE SEALANT & TRAILERING

62 MAINTENANCE & GARAGE

- 64 OIL & LUBRICANTS
- 66 GARAGE ACCESSORIES
- 68 BATTERY CHARGERS & SERVICE PARTS
- 70 POLARIS POWER

72 APPAREL

- 73 JERSEYS, GLOVES & GAITERS
- 73 RANGE COLLECTION
- 74 CASUALWEAR & HATS
- 75 HELMETS & GOGGLES

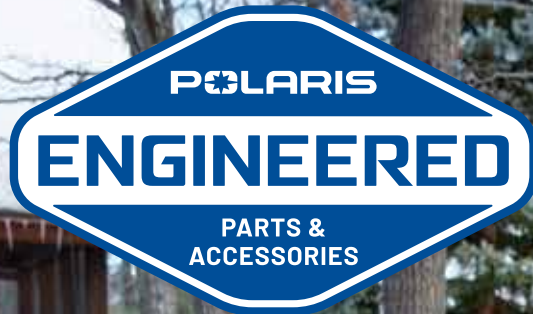

DESIGNED

by the people who designed your vehicle.

TESTED

in the field so you ride with 100% confidence.

TRUSTED

70 years in the business. The #1 name in off-road.

KEEP YOUR STANDARDS HIGH. WE DO.



WE HOLD OUR PARTNERS TO THE SAME STANDARDS

Sharing an outdoor adventure with a companion or two gives your experience its very own energy. When we meet another brand that builds and tests their products with the same rigor as we do, a kinship forms. So we give them an exclusive partner badge and invite them along for the ride. It's another way we bring you the best options for customizing your Polaris vehicle without compromise. How better to send you and your crew out into the world?



ENGINEERED FOR MORE

Ensuring Polaris Engineered Accessories fit and work in sync with your machine is the most critical phase of testing and validation. With seamless integration, you can trust that any Polaris accessory you install will enhance your experience beyond your expectations.



CARGO VERSATILITY

Lock & Ride mounting locations allow for limitless customization to let you work the way you want.

P. 15, 20, 30

POLARIS RIDE COMMAND

ENHANCE YOUR RIDE

Ride in confidence with industry-leading technology showing you the way.

P. 48



PRO HD SERIES HEAVY DUTY WINCHES

INTEGRATED WINCH MOUNT & PRE-WIRED

Designated mounting points and pre-wired connectors for a perfect fit and the strongest place to attach a Polaris Engineered winch - the most dependable winch for your Sportsman. With wiring built right into the vehicle, we made this the easiest winch to install on a Sportsman.

P. 40

GLACIER PLOW SYSTEMS

INTEGRATED PLOW MOUNT

The attachment points for the Glacier Plow System are integrated right at the factory and feature an innovative drive-up and go installation process.

P. 42

SUPERIOR INTEGRATION

PRO HD SERIES HEAVY DUTY WINCHES



✓ Pre-wired chassis & no need to cut panels

Factory-installed wiring makes the controls simple to install. Mount the winch, connect the wires and trust that everything is routed safely, securely, and properly.

- ✓ Tested 1,200+ pulls at max load
- ✓ Built to withstand -29° C temperatures
- ✓ Operates fully submerged underwater
- ✓ Military tested and approved



- ① Sealed permanent magnet motor
- ② Cut steel gears and sealed drivetrain

③ PREMIUM SYNTHETIC ROPE

With its lightweight, yet extremely strong, design and superior flexibility, this 15.2 m long synthetic rope is easy to handle and can stand up to any tough job.

④ RAPID ROPE RECOVERY 5x FASTER

Retrieve cable 5x faster than standard mode on other Polaris winches. Get back to riding or complete your task quicker.

⑤ AUTO STOP TECHNOLOGY

Auto Stop technology protects and extends the life of your winch by automatically stopping the winch at the end of pull to prevent over-spooling. While plowing, it prevents the plow frame from bending by stopping the winch once the plow has been lifted.

✓ WIRELESS REMOTE

This convenient remote operates your Polaris winch wirelessly from within 15.2 m of the vehicle. Operate your winch safely outside your vehicle while on the job site or trails.

LEARN MORE ABOUT POLARIS ENGINEERED WINCHES

P. 40

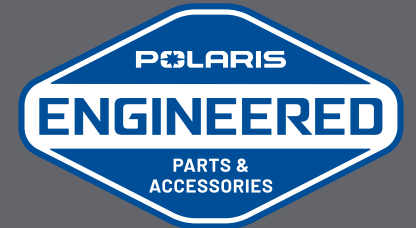

Right from the factory, your vehicle is built to make essential accessories like winches and plows easy to use day-in and day-out. Mounting brackets are designed into the oversized factory bumper and wiring is routed securely and properly. When it comes to Sportsman, Polaris Engineered Accessories make work easier so you can get more done.

GLACIER PLOW SYSTEMS



- ✓ Easily install and remove the plow system from your Sportsman
- ✓ No loss of factory ground clearance when not plowing
- ✓ Don't have to crawl under the machine to release the plow blade from the vehicle
- ✓ No trimming of vehicle plastic required to mount plow or winch
- ✓ Angle your blade right from your seat with the Glacier Pro Plow Hydraulic Angle System
- ✓ 30 seconds: Drive up, hook on, lock down, and go

LEARN MORE ABOUT THE GLACIER PLOW SYSTEM

P. 42



DRIVE UP



HOOK ON



LOCK DOWN

SPORTSMAN

450
570

SHOP BY USE

PACKAGES MADE FOR THE WAY YOU SPORTSMAN

TRAIL RIDING PACKAGE

- 2884844 Trail Brushguard P. 13
- 2890579-266 Handguards P. 14
- 2889070 Rear Power Harness P. 14
- 2885002 Hand & Thumb Warmer Kit P. 14
- 2891010 Storage Bin Net P. 15
- 2884987 Audio Storage Box Remote P. 15
- 2891194 Pod Bag P. 15
- 2891193 Fender Bag P. 15
- 2890878 **LR** Audio Cargo Box P. 20
- 2883128 RIGID® D-Series Pro Driving LED Light P. 46

- 2882320 Lightbar Harness P. 47
- 2879860 LED Y-Harness P. 47
- 2883140 Pro Armor Wheel & Tire Set: Dual Threat/4202 P. 59
- 2877385 Lug Nuts P. 59

LANDOWNER PACKAGE

- 2884842 Front Utility Rack P. 13
- 2884850 HD Front Brushguard with Hitch P. 13
- 2891010 Storage Bin Net P. 15
- 2890617 **LR** Mid 39.4cm Clear Windshield P. 16
- 2889864 Rear Rack Extender P. 20
- 2890877 **LR** Open Cargo Box P. 20
- 2882385 Pro Armor Wheel & Tire Set: Harvester/4204 P. 59
- 2877385 Lug Nuts P. 59

HUNT PACKAGE

- 2884850 HD Front Brushguard with Hitch P. 13
- 2885002 Hand & Thumb Warmer Kit P. 14
- 2891010 Storage Bin Net P. 15
- 2890617 **LR** Mid 39.4 cm Clear Windshield P. 16
- 2889864 Rear Rack Extender P. 20
- 2890581 **LR** Semi-Rigid Storage Bag P. 21
- 2883123 RIGID® SR-Series 25 cm Combo LED Light P. 47
- 2882320 Lightbar Harness P. 47

- 2882426 Kolpin Stronghold Gun Boot L P. 50
- 2884846 Kolpin Stronghold Auto-Latch Mount P. 50
- 2884119 **LR** Kolpin Rhino Grip Pro P. 51
- 2881360 Pro Armor Wheel & Tire Set: Attack 2.0/4205 P. 59
- 2877385 Lug Nuts P. 59

WINTER PACKAGE

- 2884850 HD Front Brushguard with Hitch P. 13
- 2885002 Hand & Thumb Warmer Kit P. 14
- 2890616 **LR** Tall 48.9 cm Clear Windshield P. 16
- 2890876 Rear Cargo Box P. 20
- 2881424 Glacier Integrated Plow Mount P. 43
- 2879630 **LR** Glacier Pro Steel ATV Plow Frame P. 43

- 2880269 Glacier Pro Plow Blade - 168 cm Poly P. 43
- 2883123 RIGID® SR-Series 25 cm Combo LED Light P. 46
- 2882320 Lightbar Harness P. 47

SPORTSMAN

450
570



NEED A PLOW? P. 42

WINCHES



PRO HD SERIES

POLARIS PRO HD 1,588 KG WINCH TOP SELLER

- Adds 1,588 kg of pulling capacity with Auto Stop Technology for plowing applications
- Rapid Rope Recovery recovers open cable 5x as fast as standard mode on other Polaris winches

» 2884834
SPORTSMAN 450/570 '21-25



HD SERIES

POLARIS HD 1,588 KG WINCH

- Adds 1,588 kg of pulling capacity with quick and easy installation
- Includes all components required for installation plus 15m of .5 cm premium high-strength synthetic rope

» 2884833
SPORTSMAN 450/570 '21-25



HD SERIES

POLARIS HD 1,134 KG WINCH TOP SELLER

- Adds 1,134 kg of pulling capacity with quick and easy installation
- Includes all components required for installation plus 15m of .5 cm high-strength steel cable

» 2884832
SPORTSMAN 450/570 '21-25



LEARN MORE P. 40

RACKS



FRONT UTILITY RACK TOP SELLER

- Tubular steel rack that attaches on top of front plastic rack providing protection and multiple tie down points
- 1.9 cm diameter matte black steel tube

» 2884842
SPORTSMAN 450/570 '21-25, EXCEPT '21 AND PRIOR 6X6, X2 AND TOUR MODELS
DOES NOT WORK WITH KOLPIN STRONGHOLD AUTO-LATCH GUN MOUNT (2884846)



REAR UTILITY RACK TOP SELLER

- Replaces rear plastic rack with a strong flat steel rack with integrated tie down points
- Works with all Lock & Ride accessories, rack extenders, and gun mounts

» 2884843
SPORTSMAN 450/570 '21-25



CARGO RACK

- Provides extra storage and a sturdy platform for securing items to the back of your ATV
- Replaces your stock rear bumper while increasing your rack size by 33%
- Virtually limitless number of tie-down points
- Has a steel matte black finish

» 2891223
SPORTSMAN 450/570 '21-25
WILL NOT WORK WITH REAR BUMPER; SERVES AS REAR BUMPER / REAR CARGO RACK



REAR RACK EXTENDER TOP SELLER

- Forms a 7.6 cm tall perimeter around the rear cargo rack to keep gear secure and keeping cargo from sliding off the rear platform
- Durable steel construction provides a sturdy tie down anchor for loose gear
- Compatible with Cargo Boxes and Rear Utility Rack

» 2884841
SPORTSMAN 450/570 '21-25

PROTECTION



TRAIL BRUSHGUARD TOP SELLER

- Provides enhanced protection from brush and debris
- Has designated light bar holes and is compatible with winch and Body Armor

» 2884844
SPORTSMAN 450/570 '21-25



REAR BRUSHGUARD TOP SELLER

- Protect your vehicle from brush, sticks, rocks and light bumps into solid objects
- Made of sturdy 3.2 cm steel tube with a matte black finish

» 2884847
SPORTSMAN 450/570 '21-25



HD FRONT BRUSHGUARD WITH HITCH

- Adds heavy-duty protection with a custom look
- Has designated light bar holes and is compatible with winch and Body Armor
- Standard front receiver hitch for additional functionality

» 2884850
SPORTSMAN 450/570 '21-25



FRONT BOOT GUARDS

- Made from High Density Poly Ethylene (HDPE)
- Comes with two front guards, one for the left and right
- Protects the CV boot

» STRUT A ARM • 2890059

» DUAL A ARM • 2890064
SPORTSMAN 450/570 '21-25



REAR BOOT GUARDS

- Made from High Density Poly Ethylene (HDPE)
- Comes with two rear guards, one for the left and right
- Protects the CV boot

» 2890866
SPORTSMAN 450/570 '21-25



BODY ARMOR

- Provides extra protection to your ATV's full body and fenders

» 2884851
SPORTSMAN 450/570 '21-25
FRONT BUMPER (2884850 OR 2884844) REQUIRED FOR INSTALLATION
DOES NOT WORK WITH KOLPIN STRONGHOLD AUTO-LATCH GUN MOUNT (2884846)

SPORTSMAN

450
570



AUDIO



AUDIO STORAGE BOX REMOTE

- Easily control the volume or switch to the next song on your Rear Audio Storage Box
- Conveniently mounts to your ATV's handlebars

» 2884987
SPORTSMAN 450/570 '21-25



AUDIO CARGO BOX

- Dual 15.2 cm speakers by Rockford Fosgate that connect via Bluetooth
- Mounts easily with Lock & Ride to the rear rack and is compatible with rack extenders, utility rack, and gun mount
- Rest easy knowing that your speakers are protected with a sealed-lid container
- Rear Power Harness required for installation (2889070)

» 2890878
SPORTSMAN 450/570 '21-25

STORAGE



SEMI-RIGID STORAGE BAG

- Fits on either side of rear rack providing riders with more storage options
- Mounts easily with Lock & Ride
- Base is water-resistant to keep your gear dry

» 2890581
SPORTSMAN 450/570 '21-25

POD BAG

- Keep your essentials in reach with 2 liters of storage capacity
- Mounts to the top of the light pod with HD Velcro
- Semi-rigid construction and PU laminated EVA material keeps belongings protected from the elements
- Compatible with windshields

» 2891194
SPORTSMAN 450/570 '21-25



FENDER BAG

- Provides easy-access 8.3 liters of storage
- Mounts to the front left fender with HD Velcro
- Semi-rigid construction and PU laminated EVA material keeps belongings protected from the elements

» 2891193
SPORTSMAN 450/570 '21-25



UNDERSEAT BAG

- Provides an extra 8.3 liters of storage capacity
- Mounts directly under your seat via a Velcro wrap
- Durable semi-rigid construction keeps items protected

» 2889454
SPORTSMAN 450/570 '21-25



OPEN CARGO BOX

- Increase your storage with an extra 83.3 liters of convenient storage space
- Mounts easily with Lock & Ride to the rear rack and is compatible with rack extenders, utility rack, and gun mount
- Holds two 18.9-liter buckets with integrated grab handle to make it easy to carry and transport cargo
- 12 convenient tie-down locations to secure cargo

» 2890877
SPORTSMAN 450/570 '21-25



REAR COOLER BOX

- Increase your storage with an extra 43.5 liters of weather resistant cooler storage
- Mounts easily with Lock & Ride to the rear rack and is compatible with rack extenders, utility rack, and gun mount
- Integrated bottle opener and 2 padlock locations

» 2890879
SPORTSMAN 450/570 '21-25



COMFORT



HANDGUARDS

- Handguard Mount (2889341) is required when installing Polaris Handguards
- Does not fit with windshields

<input type="checkbox"/> BRIGHT WHITE	2876883
<input checked="" type="checkbox"/> BLACK <small>TOP SELLER</small>	2876846
<input type="checkbox"/> INDY RED	2876845

» MOUNT • 2889341
SPORTSMAN 450/570 '21-25



LED LIGHT KIT

- Upgrade your standard headlights and pod lights to LEDs with this upgrade kit

» 2884859
SPORTSMAN 450/570 '21-25



HAND & THUMB WARMER KIT TOP SELLER

- Provides heat to grips and throttle and is easily installed by plugging into pod
- Includes two heated grips and one throttle warmer

» 2885002
SPORTSMAN 450/570 '21-25



HANDLEBAR MOUNTED MIRRORS TOP SELLER

- Enhances visibility of what's behind you for added safety
- Sold as a pair

» NEW 2890578
» 2877222
SPORTSMAN 450/570 '21-25



ULTIMATE SERIES HANDGUARD KIT

- Protects riders from wind, snow, ice, branches, and other trail debris
- Larger design offers increased level of warmth and protection
- Ultimate Series Handguard Kit includes mounts

<small>NEW</small> POLARIS PURSUIT CAMO	2890579-587
BLACK	2890579-266

SPORTSMAN 450/570 '21-25
NOT COMPATIBLE WITH WINDSHIELDS



REAR POWER HARNESS

- Provides power to the rear of the ATV for electrical accessories including Rear Audio Storage Box

» 2889070
SPORTSMAN 450/570 '21-25

SPORTSMAN
450
570



DO MORE

WINDSHIELDS



TALL 48.9 CM CLEAR
2890616



MEDIUM 39.4 CM CLEAR
2890617



TALL 48.9 CM CLEAR
FOR RIDE COMMAND
EQUIPPED VEHICLES
2890618

WINDSHIELDS

- Lock & Ride technology allows for easy installation and removal in seconds without tools
- Poly windshields are flexible, impact-resistant, and provide long-term value over the life of your machine
- Two heights available for whatever coverage you prefer

SIZE	COLOR	PART #
TALL 48.9 CM	CLEAR	2890616
MEDIUM 39.4 CM	CLEAR	2890617

SPORTSMAN 450/570 '21-25

FOR RIDE COMMAND EQUIPPED VEHICLES

TALL 48.9 CM	CLEAR	2890618
--------------	-------	---------

SPORTSMAN 450/570 '23-25 WITH 7" DISPLAY INSTALLED



PLOWS P. 42



WHEELS & TIRES P. 54



LIGHTING P. 46



HUNT P. 50

INTRODUCING THE NEW

SPORTSMAN
570 X2
570 6x6
TOURING 570

SHOP BY USE

PACKAGES MADE FOR THE WAY YOU SPORTSMAN

TRAIL RIDING PACKAGE



LANDOWNER PACKAGE



- 2890878 **LR** Audio Cargo Box P. 20
- 2891010 Storage Bin Net P. 21
- 2884987 Audio Storage Box Remote P. 21
- 2890579-266 Handguards P. 23
- 2891194 Pod Bag P. 21
- 2889866 Rear Cargo Box Support P. 21
- 2891193 Fender Bag P. 21
- 2884844 Trail Brushguard P. 22
- 2889908 Passenger Handguards P. 22
- 2889886 Rear Power Harness P. 23
- 2885002 Hand & Thumb Warmer Kit P. 23
- 2883128 RIGID® D-Series Pro Driving LED Light P. 46
- 2882320 Lightbar Harness P. 47
- 2879860 LED Y-Harness P. 47
- 2883140 Pro Armor Wheel & Tire Set: Dual Threat/4202 P. 59
- 2877385 Lug Nuts P. 59

- 2890877 **LR** Open Cargo Box P. 20
- 2884842 Front Utility Rack P. 20
- 2891000 Rear Rack Filler Plate P. 21
- 2891010 Storage Bin Net P. 21
- 2889866 Rear Cargo Box Support P. 21
- 2884850 HD Front Brushguard with Hitch P. 22
- 2890617 **LR** Mid 39.4 cm Clear Windshield P. 23
- 2882385 Pro Armor Wheel & Tire Set: Harvester/4204 P. 59
- 2877385 Lug Nuts P. 59

HUNT PACKAGE



WINTER PACKAGE



- 2891010 Storage Bin Net P. 21
- 2890581 **LR** Semi-Rigid Storage Bag P. 21
- 2889866 Rear Cargo Box Support P. 21
- 2884850 HD Front Brushguard with Hitch P. 22
- 2885002 Hand & Thumb Warmer Kit P. 23
- 2890617 **LR** Mid 39.4 cm Clear Windshield P. 23
- 2883123 RIGID® SR-Series 25 cm Combo LED Light P. 47
- 2882320 Lightbar Harness P. 47
- 2882426 Kolpin Stronghold Gun Boot L P. 50
- 2884846 Kolpin Stronghold Auto-Latch Mount P. 50
- 2884119 **LR** Rhino Grip Pro P. 51
- 2881360 Pro Armor Wheel & Tire Set: Attack 2.0/4205 P. 59
- 2877385 Lug Nuts P. 59
- 2890876 **LR** Cargo Box P. 20
- 2889866 Rear Cargo Box Support P. 21
- 2884850 HD Front Brushguard with Hitch P. 22
- 2885002 Hand & Thumb Warmer Kit P. 23
- 2889887 Driver Heated Seat P. 23
- 2889888 Passenger Heated Seat P. 23
- 2889906 Passenger Heated Grips P. 23
- 2890616 **LR** Tall 48.9 cm Clear Windshield P. 23
- 2881424 Glacier Integrated Plow Mount P. 43
- 2879630 **LR** Glacier Pro Steel ATV Plow Frame P. 43
- 2880269 Glacier Pro Plow Blade - 168 cm Poly P. 43
- 2883123 RIGID® SR-Series 10" Combo LED Light P. 47
- 2882320 Lightbar Harness P. 47

SPORTSMAN 570 X2 570 6x6 TOURING 570



STORAGE & RACKS



REAR RACK EXTENDER

- Forms a 3" tall perimeter around the rear cargo rack to keep gear secure
- Durable steel construction provides a sturdy tie down anchor for gear

» 2889864

SPORTSMAN TOURING 570 '25
NOT COMPATIBLE WITH THE REAR CARGO BOX SUPPORT (2889866)



OPEN CARGO BOX

- 22 gallons of storage
- Mounts easily with Lock & Ride

» 2890877

SPORTSMAN TOURING 570 '25
REAR CARGO BOX SUPPORT (2889866) REQUIRED, SOLD SEPARATELY



CARGO BOX

- 21.25 gallons of storage
- Mounts easily with Lock & Ride
- Molded-in storage tray for organizing smaller items

» 2890876

SPORTSMAN TOURING 570 '25
REAR CARGO BOX SUPPORT (2889866) REQUIRED, SOLD SEPARATELY



COOLER CARGO BOX

- 44 quart cooler
- Mounts easily with Lock & Ride
- Tough molded UV-resistant polyethylene construction for optimal ice retention

» 2890879

SPORTSMAN TOURING 570 '25
REAR CARGO BOX SUPPORT (2889866) REQUIRED, SOLD SEPARATELY



AUDIO CARGO BOX

- 80 liters of storage
- Dual 6.5" Rockford Fosgate® speakers that connect via Bluetooth®
- Molded-in storage tray for organizing smaller items
- Mounts easily with Lock & Ride

» 2890878

SPORTSMAN TOURING 570 '25
REAR POWER HARNESS (2889866) REQUIRED, SOLD SEPARATELY
REAR CARGO BOX SUPPORT (2889866) REQUIRED, SOLD SEPARATELY



FRONT UTILITY RACK TOP SELLER

- Tubular steel rack that attaches on top of front plastic rack providing protection and multiple tie down points
- 1.9 cm diameter matte black steel tube

» 2884842

SPORTSMAN X2 570 '25, SPORTSMAN 6X6 570 '25, SPORTSMAN TOURING 570 '25
DOES NOT WORK WITH KOLPIN STRONGHOLD AUTO-LATCH GUN MOUNT (2884846)



SEMI-RIGID STORAGE BAG

- Fits on either side of rear rack providing riders with more storage options
- Mounts easily with Lock & Ride
- Base is water-resistant to keep your gear dry

» 2890581

SPORTSMAN TOURING 570 '25



PASSENGER SEAT BAG

- Straps mount around the rear passenger seat or doubles as a backpack
- Easily add and remove the bag at your convenience
- Semi-rigid compression molded design
- Tapered design allows access to rear storage bin

» 2890060

SPORTSMAN TOURING 570 '25



REAR RACK FILLER PLATE

- Fills the space between the driver seat and rear rack when the rear passenger seat is removed
- Fits in Rear Rack Storage Bin when not in use

» 2891000

SPORTSMAN TOURING 570 '25

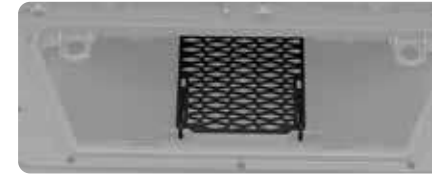

STORAGE BIN NET

- Secure all of your small items and gear
- Made of high quality EPDM rubber

» 2891010

SPORTSMAN TOURING 570 '25



REAR CARGO BOX SUPPORT

- Allows mounting of cargo boxes when rear seat is installed

» 2889866

SPORTSMAN TOURING 570 '25
REQUIRED FOR TOURING 570
NOT COMPATIBLE WITH REAR BUMPER (2890001), REAR RACK EXTENDER (2889864) OR REAR CARGO RACK (2890037)



AUDIO STORAGE BOX REMOTE

- Easily control the volume or switch to the next song on your Rear Audio Storage Box
- Conveniently mounts to handlebars

» 2884987

SPORTSMAN X2 570 '25, SPORTSMAN 6X6 570 '25, SPORTSMAN TOURING 570 '25



FENDER BAG

- Provides easy-access 8.3 liters of storage
- Mounts to the front left fender with HD Velcro
- Semi-rigid construction and PU laminated EVA material keeps belongings protected from the elements

» 2891193

SPORTSMAN X2 570 '25, SPORTSMAN 6X6 570 '25, SPORTSMAN TOURING 570 '25



POD BAG

- Keep your essentials in reach with 2 Liters of storage capacity
- Mounts to the top of the light pod with HD Velcro
- Semi-rigid construction and PU Laminated EVA material keeps belongings protected from the elements
- Compatible with windshields

» 2891194

SPORTSMAN X2 570 '25, SPORTSMAN 6X6 570 '25, SPORTSMAN TOURING 570 '25

WINCHES



PRO HD SERIES

POLARIS PRO HD 1,588 KG WINCH

- Adds 1,588 kg of pulling capacity with Auto Stop Technology for plowing applications
- Rapid Rope Recovery recovers open cable 5x as fast as standard mode on other Polaris winches

» 2884834

SPORTSMAN X2 570 '25, SPORTSMAN 6X6 570 '25, SPORTSMAN TOURING 570 '25



HD SERIES

POLARIS HD 1,588 KG WINCH

- Adds 1,588 kg of pulling capacity with quick and easy installation
- Includes all components required for installation plus 15m of .5 cm premium high-strength synthetic rope

» 2884833

SPORTSMAN X2 570 '25, SPORTSMAN 6X6 570 '25, SPORTSMAN TOURING 570 '25



HD SERIES

POLARIS HD 1,134 KG WINCH

- Adds 1,134 kg of pulling capacity with quick and easy installation
- Includes all components required for installation plus 15m of .5 cm high-strength steel cable

» 2884832

SPORTSMAN X2 570 '25, SPORTSMAN 6X6 570 '25, SPORTSMAN TOURING 570 '25



LEARN MORE P. 40

SPORTSMAN 570 X2 570 6x6 TOURING 570



COMFORT & CONVENIENCE



DRIVER HEATED SEAT

- Plug and play seat installs easily
- Direct replacement for standard seat
- Integrated heat element, wiring harness and control switch

» 2889887
SPORTSMAN TOURING 570 '25



PASSENGER HEATED SEAT

- Plug and play seat installs easily
- Direct replacement for standard seat
- Integrated heat element, wiring harness and control switch

» 2889888
SPORTSMAN TOURING 570 '25



PASSENGER HEATED GRIPS

- Keeps passenger hands warm in cold weather
- Includes all wiring and high/low switch

» 2889906
SPORTSMAN TOURING 570 '25

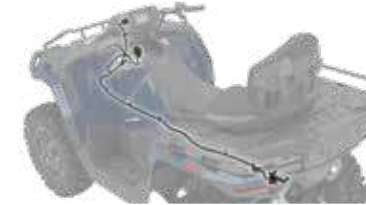

REAR POWER HARNESS

- Provides power to the rear of your ATV for easy access to hook up and run powered accessories

» 2889886
SPORTSMAN X2 570 '25, SPORTSMAN TOURING 570 '25
REQUIRED FOR AUDIO CARGO BOX (2890878), SOLD SEPARATELY



HAND & THUMB WARMER KIT TOP SELLER

- Provides heat to grips and throttle and is easily installed by plugging into pod
- Includes two heated grips and one throttle warmer

» 2885002
SPORTSMAN X2 570 '25, SPORTSMAN 6X6 570 '25, SPORTSMAN TOURING 570 '25



ULTIMATE SERIES HANDGUARD KIT

- Protects riders from wind, snow, ice, branches, and other trail debris
- Larger design offers increased level of warmth and protection
- Ultimate Series Handguard Kit includes mounts

» POLARIS PURSUIT CAMO 2890579-587
» BLACK 2890579-266

SPORTSMAN X2 570 '25, SPORTSMAN 6X6 570 '25, SPORTSMAN TOURING 570 '25
NOT COMPATIBLE WITH WINDSHIELDS

WINDSHIELDS



TALL 48.9 CM CLEAR
2890616



MEDIUM 39.4 CM CLEAR
2890617



TALL 48.9 CM CLEAR
FOR RIDE COMMAND
EQUIPPED VEHICLES
2890618

LOCK & RIDE WINDSHIELDS

- Lock & Ride technology allows for easy installation and removal in seconds without tools
- Poly windshields are flexible, impact-resistant, and provide long-term value over the life of your machine
- Two heights available for whatever coverage you prefer

SIZE	COLOR	PART #
TALL 48.9 CM	CLEAR	2890616
MEDIUM 39.4 CM	CLEAR	2890617

SPORTSMAN X2 570 '25, SPORTSMAN 6X6 570 '25, SPORTSMAN TOURING 570 '25

FOR RIDE COMMAND EQUIPPED VEHICLES

TALL 48.9 CM	CLEAR	2890618
--------------	-------	---------

SPORTSMAN X2 570 '25, SPORTSMAN 6X6 570 '25, SPORTSMAN TOURING 570 '25 WITH 7" DISPLAY POWERED BY RIDE COMMAND INSTALLED



PROTECTION



TRAIL BRUSHGUARD TOP SELLER

- Provides enhanced protection from brush and debris
- Has designated light bar holes and is compatible with winch and Body Armor

» 2884844
SPORTSMAN X2 570 '25, SPORTSMAN 6X6 570 '25, SPORTSMAN TOURING 570 '25



HD FRONT BRUSHGUARD WITH HITCH

- Adds heavy-duty protection with a custom look
- Has designated light bar holes and is compatible with winch and Body Armor
- Standard front receiver hitch for additional functionality

» 2884850
SPORTSMAN X2 570 '25, SPORTSMAN 6X6 570 '25, SPORTSMAN TOURING 570 '25



REAR BUMPER

- Durable 1.25" steel tube with a matte black finish
- Does not block access to the rear storage compartment

» 2890001
SPORTSMAN TOURING 570 '25
NOT COMPATIBLE WITH REAR CARGO BOX SUPPORT (2889866) OR REAR CARGO RACK (2890037)



PASSENGER HANDGUARDS

- Two ATV passenger handguards
- Protection for hands in all riding conditions
- Mounting is quick/easy and included

» 2889908
SPORTSMAN TOURING 570 '25

MAINTENANCE PARTS & FLUIDS

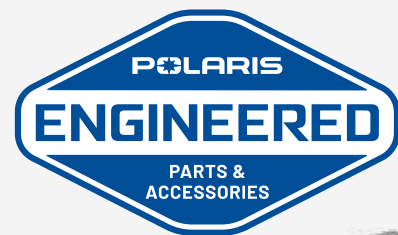

POLARIS ENGINEERED PARTS AND OIL

have been validated and tested extensively, specifically for your vehicle. In order to maintain the peak performance of your Polaris vehicle only use official Polaris Engineered parts and oil.



We're taking the passion of our riders, workers, and outdoor enthusiasts to the next level with HD Parts. These Heavy Duty parts are engineered for riders who want greater durability and enhanced performance. HD Parts are designed and tested to handle greater wear and tear under all weather conditions.

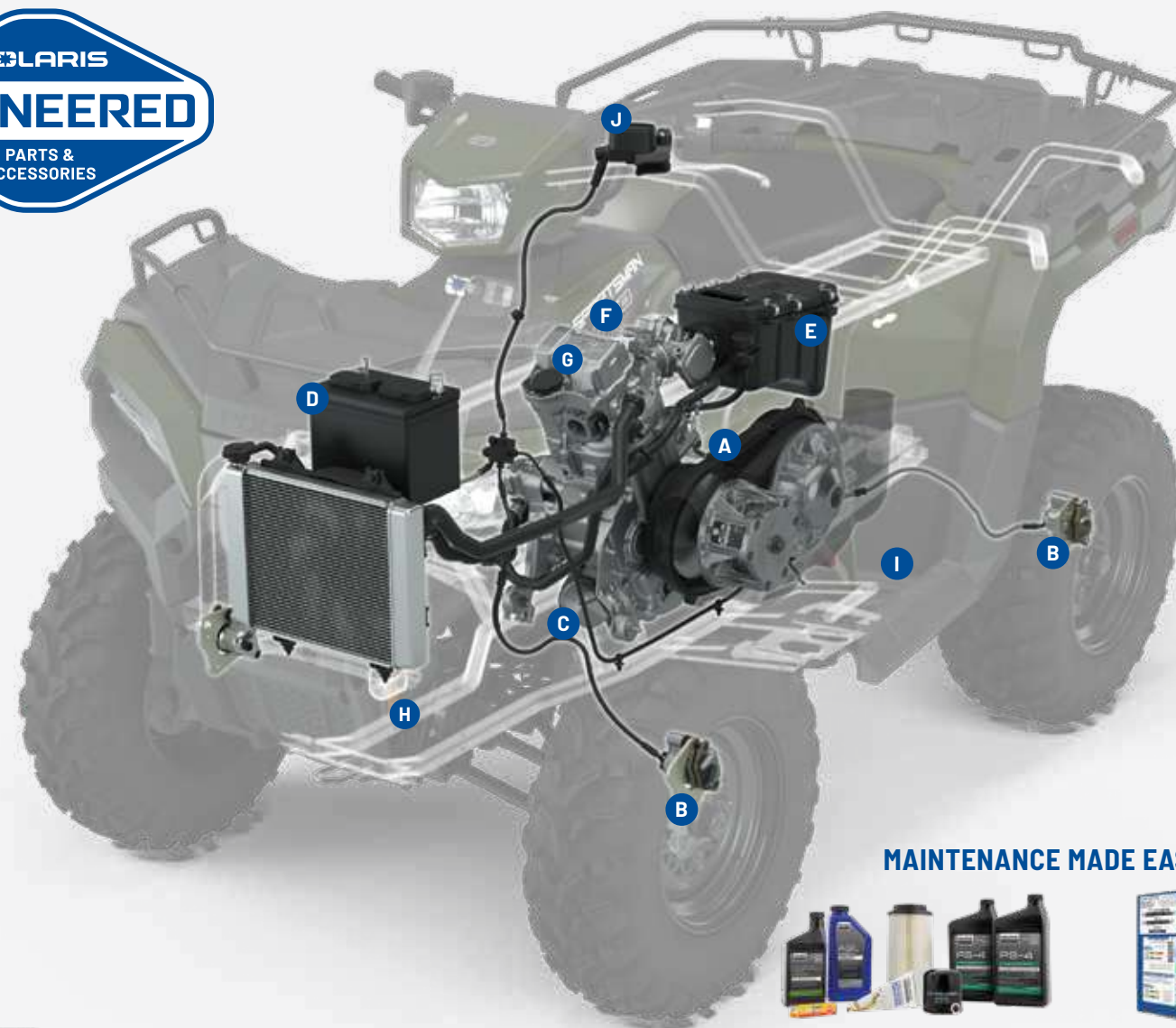

A DRIVE BELT

- » 3211113
450, 570
- » **HD** • 3212360
450, 570
- » 3211229
450 EPS (UTILITY), 570 EPS (PREMIUM, TRAIL), 570 TOURING, 570 X2, 570 6X6



B BRAKE PADS

- » FRONT & REAR • 2205606
450, 450 EPS (UTILITY), 570, 570 EPS (PREMIUM TRAIL)
- » **HD** FRONT • 2208934
570 TOURING, 570 X2, 570 6X6
- » **HD** REAR • 2208935
570 TOURING, 570 X2, 570 6X6
- » FRONT • 2202413
570 TOURING, 570 X2, 570 6X6
- » REAR • 2202412
570 TOURING, 570 X2, 570 6X6



C OIL FILTER

- » 2520799
- » **HD** • 2522485



D BATTERY

- » 4017419



E AIR FILTER

- » 7082101
- » **HD** • 7083114



F SPARK PLUGS

- » 450 • 3024016
- » 570 • 3022662

LOOKING FOR MORE SERVICE PARTS?

See P. 69 to learn how to find parts for your model.



- ### G ENGINE OIL P. 64
- » PS-4 • .95 L • 2876244
 - » PS-4 • 3.8 L • 2876245
 - » PS-4 EXTREME • .95 L • 2889395
 - » PS-4 EXTREME • 3.8 L • 2889396



- ### H DEMAND DRIVE FLUID
- For front gearcase
- » .95 L • 2877922
 - » 9.5 L • 2877923



- ### I AGL
- For transmission
- » .95 L • 2878068
 - » 3.8 L • 2878069
 - » EXTREME • .95 L • 2891028



- ### J DOT 4 BRAKE FLUID
- » 355 ML • 2872189

MAINTENANCE MADE EASY



ORV MAINTENANCE KIT

- Includes Oil Change Kit, Gearcase Fluids, Air Filter, & Spark Plug
- » 2830549
570 14-25



OIL CHANGE KITS

- 2 L Engine Oil (oil varies by kit), 1 Oil Filter (2540086) & 1 Drain Plug Washer
- » PS-4 • 2877473
 - » PS-4 EXTREME • 2890055



ALL-SEASON GREASE TUBE

- » 89 mL • 2871322
- » 414 mL • 2871423

MAINTENANCE SCHEDULE*

BREAK-IN MAINTENANCE

FIRST 25 HRS | 500 MI / 800 KM

- ENGINE OIL & OIL FILTER CHANGE
- FRONT GEARCASE CHANGE FLUID
- BRAKE PADS INSPECT
REPLACE AS NEEDED
- BRAKE FLUID INSPECT
ADD AS NEEDED
- TRANSMISSION INSPECT FLUID
ADD AS NEEDED

12 MONTHS

100 HRS | 1,000 MI / 1,600 KM

- ENGINE OIL & OIL FILTER CHANGE
- AIR FILTER INSPECT
REPLACE AS NEEDED
- BATTERY TEST & CLEAN
REPLACE AS NEEDED
- BRAKE PADS INSPECT
REPLACE AS NEEDED

- DRIVE BELT INSPECT
REPLACE AS NEEDED
- FRONT GEARCASE INSPECT
- GENERAL LUBRICATION ALL FITTINGS, PIVOTS, CABLES, ETC.
- TRANSMISSION FLUID INSPECT

24 MONTHS

200 HRS | 2,000 MI / 3,200 KM

- ENGINE OIL & OIL FILTER CHANGE
- AIR FILTER INSPECT
REPLACE AS NEEDED
- BATTERY TEST & CLEAN
REPLACE AS NEEDED
- BRAKE PADS INSPECT
REPLACE AS NEEDED
- BRAKE FLUID CHANGE

- DRIVE BELT INSPECT
REPLACE AS NEEDED
- FRONT GEARCASE INSPECT
- GENERAL LUBRICATION ALL FITTINGS, PIVOTS, CABLES, ETC.
- TRANSMISSION FLUID INSPECT
- SPARK PLUGS INSPECT
REPLACE AS NEEDED

36 MONTHS

300 HRS | 3,000 MI / 4,800 KM

- ENGINE OIL & OIL FILTER CHANGE
- AIR FILTER INSPECT
REPLACE AS NEEDED
- BATTERY TEST & CLEAN
REPLACE AS NEEDED
- BRAKE PADS INSPECT
REPLACE AS NEEDED

- DRIVE BELT INSPECT
REPLACE AS NEEDED
- FRONT GEARCASE INSPECT
- GENERAL LUBRICATION ALL FITTINGS, PIVOTS, CABLES, ETC.
- TRANSMISSION FLUID INSPECT

FOR A COMPLETE MAINTENANCE SCHEDULE, CHECK YOUR OWNER'S MANUAL

Claims made based off testing and performance of Polaris HD Parts against standard OEM parts made by Polaris and competitor brands under normal use. For more information regarding Polaris HD parts including vehicle compatibility, installation and maintenance, please contact your authorized Polaris ORV dealer.

SPORTSMAN
850
XP 1000
XP 1000 S

SHOP BY USE



PACKAGES MADE FOR THE WAY YOU SPORTSMAN

TRAIL RIDING PACKAGE

- 2882020 Ultimate Series Front Brushguard P. 29
- 2882583 Ultimate Series Rear Brushguard P. 29
- 2890878  Audio Cargo Box P. 31
- 2885002 Hand & Thumb Warmer Kit P. 31
- 2890579-266 Handguards P. 31
- 2889071 Rear Power Harness P. 31
- 2884987 Audio Storage Box Remote P. 31
- 2883128 RIGID® D-Series Pro Driving LED Light P. 46

- 2882320 Lightbar Harness P. 47
- 2879860 LED Y-Harness P. 47
- 2883140 Pro Armor Wheel & Tire Set: Dual Threat/4202 P. 59
- 2877385 Lug Nuts P. 59

LANDOWNER PACKAGE

- 2890617  Mid 39.4 cm Clear Windshield P. 28
- 2882020 Ultimate Series Front Brushguard P. 29
- 2882583 Ultimate Series Rear Brushguard P. 29
- 2890877  Open Cargo Box P. 30



- 2882385 Pro Armor Wheel & Tire Set: Harvester/4204 P. 59
- 2877385 Lug Nuts P. 59

HUNT PACKAGE

- 2890617  Mid 39.4 cm Clear Windshield P. 28
- 2882023 Ultimate Series Rear Rack Extender 4' P. 29
- 2882020 Ultimate Series Front Brushguard P. 29
- 2882583 Ultimate Series Rear Brushguard P. 29
- 2885002 Hand & Thumb Warmer Kit P. 31
- 2883123 RIGID® SR-Series 25 cm Combo LED Light P. 47
- 2882320 Lightbar Harness P. 47
- 2882426 Kolpin Stronghold Gun Boot L P. 50

- 2884846 Kolpin Stronghold Auto-Latch Mount P. 50
- 2884119  Kolpin Rhino Grip Pro P. 51
- 2881360 Pro Armor Wheel & Tire Set: Attack 2.0/4205 P. 59
- 2877385 Lug Nuts P. 59

WINTER PACKAGE

- 2890616  Tall 48.9 cm Clear Windshield P. 28
- 2882020 Ultimate Series Front Brushguard P. 29
- 2882583 Ultimate Series Rear Brushguard P. 29
- 2890876  Rear Cargo Box P. 30
- 2885002 Hand & Thumb Warmer Kit P. 31
- 2881423 Integrated Plow Mount Frame Attachment P. 43
- 2879630  Glacier Pro Steel ATV Plow Frame P. 43

- 2880269 Glacier Pro Plow Blade - 168 cm Poly P. 43
- 2883123 RIGID® SR-Series 25 cm Combo LED Light P. 47
- 2882320 Lightbar Harness P. 47

SPORTSMAN 850 XP 1000 XP 1000 S



NEED A PLOW? P. 42

WINCHES



LEARN MORE P. 40



PRO HD SERIES

POLARIS PRO HD 1,588 kg WINCH

- » 2889471 SPORTSMAN 850 '12-25, SPORTSMAN XP 1000 '15-25, SPORTSMAN TOURING XP 1000 '15-25, SPORTSMAN TOURING 850 '15-25
- » 2883580 SPORTSMAN XP 1000 S '20-25



HD SERIES

POLARIS HD 1,588 KG WINCH

- » 2889470 SPORTSMAN 850 '12-25, SPORTSMAN XP 1000 '15-25, SPORTSMAN TOURING XP 1000 '15-25, SPORTSMAN TOURING 850 '15-25



HD SERIES

POLARIS HD 1,134 KG WINCH

- » 2889469 SPORTSMAN 850 '12-25, SPORTSMAN XP 1000 '15-25, SPORTSMAN TOURING XP 1000 '15-25, SPORTSMAN TOURING 850 '15-25



WINDSHIELDS

WINDSHIELDS

- Provides enhanced protection from the elements
- Easily installs and removes without tools utilizing Lock & Ride technology
- Improved mounting system for easier and quicker attachment and detachment



TALL 48.9 CM CLEAR
2890616



MEDIUM 39.4 CM CLEAR
2890617



TALL 48.9 CM CLEAR
FOR RIDE COMMAND
EQUIPPED VEHICLES
2890618

SIZE	COLOR	PART #
TALL 48.9 CM	CLEAR	2890616
MEDIUM 39.4 CM	CLEAR	2890617

FOR RIDE COMMAND EQUIPPED VEHICLES		
TALL 48.9 CM	CLEAR	2890618
SPORTSMAN XP 1000 '22-25, SPORTSMAN 850 '22-25 WITH 7" DISPLAY POWERED BY RIDE COMMAND INSTALLED		

SPORTSMAN XP 1000 S '21-25, SPORTSMAN XP 1000 '21-25, SPORTSMAN 850 '21-25

RACKS



FRONT



REAR

ULTIMATE SERIES RACK EXTENDER 10.2 CM

- » FRONT • 2882022 SPORTSMAN 850/1000 '17-25, SPORTSMAN XP 1000 S '20-25

- » REAR • 2882023 SPORTSMAN 850/1000 '17-25, SPORTSMAN XP 1000 S '20-25
FITS WITH REAR CARGO BOX (2882882)



FRONT



REAR

ULTIMATE SERIES RACK EXTENDER 17.8 CM

- » FRONT • 2882024 SPORTSMAN 850/1000 '17-25, SPORTSMAN XP 1000 S '20-25

- » REAR • 2882025 SPORTSMAN 850/1000 '17-25, SPORTSMAN XP 1000 S '20-25
DOES NOT FIT WITH REAR CARGO BOX (2882882)



FRONT RACK EXTENDER

- » 2879890 SPORTSMAN 850/1000 TOURING '10-25
DOES NOT FIT WITH FRONT CARGO BOX (2877951)



ULTIMATE SERIES MOVABLE TIE-DOWN POINTS

- Comes as pair
- » FRONT & REAR • 2882270 SPORTSMAN 850/1000 '17-25



FRONT



REAR

ULTIMATE SERIES STEEL RACK

- » FRONT • 2883257 SPORTSMAN 850/1000 '17-25, SPORTSMAN XP 1000 S '20-25

- » REAR • 2883258 SPORTSMAN 850/1000 '17-25, SPORTSMAN XP 1000 S '20-25

PROTECTION



ULTIMATE SERIES BODY ARMOR

- Securely mounts to Ultimate Series Front Brushguard (2882020)
- Comes as pair
- » 2882090 SPORTSMAN 850/1000 '17-25
DOES NOT WORK WITH GUN BOOT MOUNT (2882036)



FRONT



REAR

ULTIMATE SERIES BRUSHGUARD

- Quick installation to the integrated mounting tubes on the vehicle using wedge-style expansion anchor mounts
- Attach the Ultimate Series Body Armor to the Front Brushguard to provide the ultimate protection for the front fenders

TOP SELLER

- » FRONT • 2882020 SPORTSMAN 850/1000 '17-25, SPORTSMAN XP 1000 S '20-25
- » REAR • 2882583 SPORTSMAN 850/1000 '17-25, SPORTSMAN XP 1000 S '20-25



FRONT



REAR

TOURING XP BRUSHGUARD

- Adds heavy-duty protection and a custom look
- » FRONT • 2878709 SPORTSMAN 850/1000 TOURING '10-25
- » REAR • 2878324 SPORTSMAN 850/1000 TOURING '10-25

SPORTSMAN 850 XP 1000 XP 1000 S

STORAGE



NEW

REAR CARGO BOX

- Increase your storage with an extra 80.4 liters of dry, dust-proof storage
 - Mounts easily with Lock & Ride to the rear rack and is compatible with rack extenders and gun mount
 - Includes 2 padlock locations
- » 2890876
SPORTSMAN 850/1000 '17-25, SPORTSMAN XP 1000 S '20-25
WILL NOT FIT WHEN ULTIMATE SERIES STEEL RACK IS INSTALLED



NEW

OPEN CARGO BOX

- Increase your storage with an extra 83.3 liters of convenient storage space
 - Mounts easily with Lock & Ride to the rear rack and is compatible with rack extenders and gun mount
 - Holds 2, 18.9-liter buckets with integrated grab handle to make it easy to carry and transport cargo
 - 12 convenient tie-down locations to secure cargo
 - Includes 2 padlock locations
- » 2890877
SPORTSMAN 850/1000 '17-25, SPORTSMAN XP 1000 S '20-25
WILL NOT FIT WHEN ULTIMATE SERIES STEEL RACK IS INSTALLED



NEW

REAR COOLER BOX

- Increase your storage with an extra 46 quarts of weather-resistant cooler storage space
 - Mounts easily with Lock & Ride to the rear rack and is compatible with rack extenders and gun mount
 - Integrated bottle opener and 2 padlock locations
- » 2890879
SPORTSMAN 850/1000 '17-25, SPORTSMAN XP 1000 S '20-25
WILL NOT FIT WHEN ULTIMATE SERIES STEEL RACK IS INSTALLED



NEW

POD BAG

- Keep your essentials in reach with 2 liters of storage capacity
 - Mounts to the top of the light pod with HD Velcro
 - Semi-rigid construction and PU laminated EVA material keeps belongings protected from the elements
 - Compatible with windshields
- » 2891194
SPORTSMAN 850/1000 '21-25



NEW

SEMI-RIGID STORAGE BAG

- Fits on either side of rear rack providing riders with more storage options
 - Mounts easily with Lock & Ride
 - Base is water-resistant to keep your gear dry
- » 2890581
SPORTSMAN 850/1000 '17-25, SPORTSMAN XP 1000 S '20-25



ULTIMATE SERIES READY PACK

- Keep your trail essentials at the ready with this easy-to-access, weather-resistant storage compartment
- » 2882271
SPORTSMAN 850/1000 '17-25



FRONT CARGO BOX

- » 2877951
SPORTSMAN 850/1000 TOURING '10-25
FRONT RACK EXTENDER CANNOT BE INSTALLED AT THE SAME TIME AS FRONT CARGO BOX



REAR STORAGE BOX

- » 2878000
SPORTSMAN 850/1000 TOURING '10-25
SLIGHT INTERFERENCE WITH SPORTSMAN TOURING 550/850 '11-14 PASSENGER HANDLES
DOES NOT FIT '21 TOURING MODELS

AUDIO



AUDIO STORAGE BOX REMOTE

- Easily control the volume or switch to the next song on your Rear Audio Storage Box
 - Conveniently mounts to your ATV's handlebars
- » 2884987
SPORTSMAN 850/1000 '17-25, SPORTSMAN XP 1000 S '20-25



NEW

AUDIO CARGO BOX

- Dual 15.2 cm speakers by Rockford Fosgate that connect via Bluetooth
 - Mounts easily with Lock & Ride to the rear rack and is compatible with rack extenders and gun mount
 - Speakers are protected with a sealed-lid container
- » 2890878
SPORTSMAN 850/1000 '17-25, SPORTSMAN XP 1000 S '20-25
REAR POWER HARNESS (2889071) IS REQUIRED, SOLD SEPARATELY



REAR POWER HARNESS

- Provides power to the rear of the ATV for electrical accessories including Rear Audio Storage Box
- » 2889071
SPORTSMAN XP 1000 '17-25, SPORTSMAN 850 '17-25, SPORTSMAN XP 1000 S '20-25

COMFORT



2890578



2877222

HANDLEBAR MOUNTED MIRRORS TOP SELLER

- Enhances visibility of what's behind you for added safety
 - Sold as a pair
- » NEW 2890578
» 2877222
SPORTSMAN 850/1000 TOURING '10-25, SPORTSMAN 850/1000 '09-25, SPORTSMAN XP 1000 S '20-25



HAND & THUMB WARMER KIT TOP SELLER

- Provides heat to grips and throttle and is easily installed by plugging into pod
 - Includes two heated grips and one throttle warmer
- » KIT • 2885002
SPORTSMAN XP 1000 S '20-25, SPORTSMAN 850/1000 '15-25, SPORTSMAN TOURING 850/1000 '15-25
» JUMPER HARNESS • 2890685
REQUIRED FOR THE FOLLOWING MODELS: SPORTSMAN XP 1000 S '20, SPORTSMAN 850/1000 '15-25, SPORTSMAN TOURING 850/1000 '15-25



ULTIMATE SERIES HANDGUARD KIT

- Larger design offers increased protects from wind, snow, ice, branches, and other trail debris
 - Mounts included
- » NEW
■ POLARIS PURSUIT CAMO 2890579-587
■ BLACK 2890579-266

SPORTSMAN 850/1000 TOURING '10-25, SPORTSMAN 850/1000 '09-25, SPORTSMAN XP 1000 S '20-25
NOT COMPATIBLE WITH WINDSHIELDS



HANDGUARDS

- Handguard Mount (2889341) is required when installing Polaris Handguards
- SPORTSMAN 850/1000 TOURING '10-25, SPORTSMAN 850/1000 '09-25, SPORTSMAN XP 1000 S '20-25
NOT COMPATIBLE WITH WINDSHIELDS
- | | | |
|---|---------|-------------------|
| <input type="checkbox"/> BRIGHT WHITE | 2876883 | » MOUNT • 2889341 |
| <input checked="" type="checkbox"/> BLACK <small>TOP SELLER</small> | 2876846 | |
| <input checked="" type="checkbox"/> INDY RED | 2876845 | |



DO MORE



PLOWS P. 42



WHEELS & TIRES P. 54



LIGHTING P. 46



HUNT P. 50

MAINTENANCE PARTS & FLUIDS

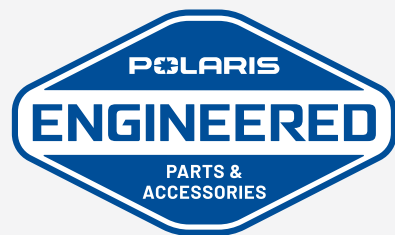

POLARIS ENGINEERED PARTS AND OIL have been validated and tested extensively, specifically for your vehicle. In order to maintain the peak performance of your Polaris vehicle only use official Polaris Engineered parts and oil.



We're taking the passion of our riders, workers, and outdoor enthusiasts to the next level with HD Parts. These Heavy Duty parts are engineered for riders who want greater durability and enhanced performance. HD Parts are designed and tested to handle greater wear and tear under all weather conditions.

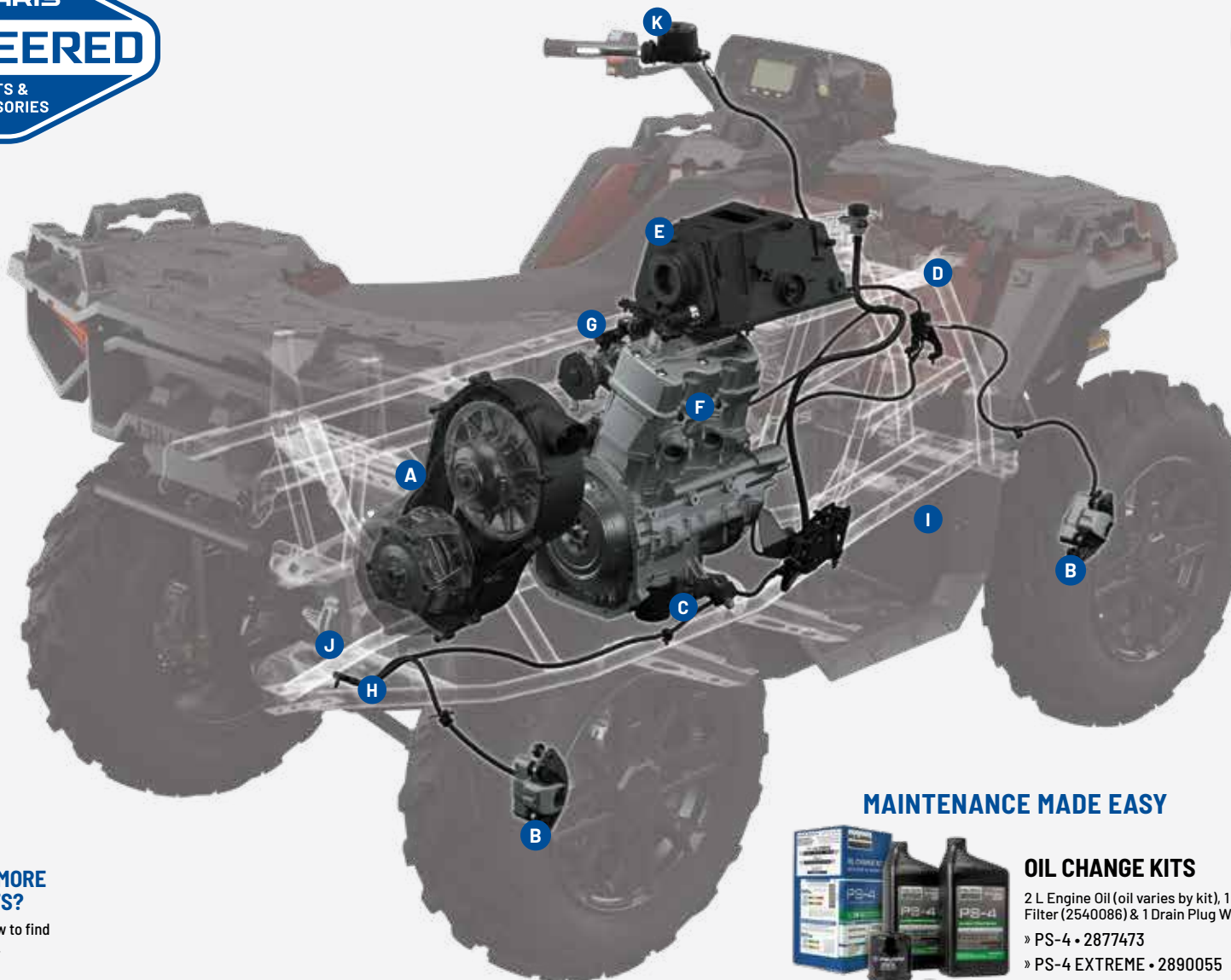

A DRIVE BELT

- » 3211160
850, XP 1000, 850 TOURING, XP 1000 TOURING
- » 3212329
XP 1000 S
- » 3211203
850/ XP 1000 HIGH LIFTER
- » **HD** • 3212331
850, XP 1000, 850 TOURING, XP 1000 TOURING, XP 1000 S

B BRAKE PADS

- » FRONT & REAR • 2205606
850, XP 1000
- » FRONT • 2205606
XP 1000 S
- » REAR • 2208936
XP 1000 S
- » FRONT & REAR • 2207835
850/ XP 1000 HIGH LIFTER

C OIL FILTER

- » 2520799
- » **HD** • 2522485

D BATTERY

- » 4014609

E AIR FILTER

- » 7082101
- » **HD** • 7083114

F SPARK PLUGS

- » 3022438
850, 850 TOURING
- » 3022553
XP 1000, XP 1000 S, XP 1000 TOURING

LOOKING FOR MORE SERVICE PARTS?

See P. 69 to learn how to find parts for your model.

G ENGINE OIL P. 64

- » PS-4 • .95 L • 2876244
- » PS-4 • 3.8 L • 2876245
- » PS-4 EXTREME • .95 L • 2889395
- » PS-4 EXTREME • 3.8 L • 2889396

H ANGLE DRIVE FLUID

- For rear gearcase
- » .95 L • 2889280

I DEMAND DRIVE FLUID

- For front gearcase
- » .95 L • 2877922
- » 9.5 L • 2877923

J AGL

- For transmission
- » .95 L • 2878068
- » 3.8 L • 2878069
- » EXTREME • .95 L • 2891028

K DOT 4 BRAKE FLUID

- » 355 ML • 2872189

ALL-SEASON GREASE TUBE

- » 89 mL • 2871322
- » 414 mL • 2871423

MAINTENANCE MADE EASY



OIL CHANGE KITS

- 2 L Engine Oil (oil varies by kit), 1 Oil Filter (2540086) & 1 Drain Plug Washer
- » PS-4 • 2877473
- » PS-4 EXTREME • 2890055

MAINTENANCE SCHEDULE*

BREAK-IN MAINTENANCE

FIRST 25 HRS | 250 MI / 400 KM

- ENGINE OIL & OIL FILTER CHANGE**
- AIR FILTER INSPECT**
REPLACE AS NEEDED
- FRONT & REAR GEARCASE INSPECT FLUID**
- TRANSMISSION CHANGE FLUID**

6 MONTHS

50 HRS | 500 MI / 800 KM

- DRIVE BELT INSPECT**
REPLACE AS NEEDED
- AIR FILTER INSPECT**
REPLACE AS NEEDED
- BATTERY TEST & CLEAN**
REPLACE AS NEEDED
- GENERAL LUBRICATION**
ALL FITTINGS, PIVOTS, CABLES, ETC.

12 MONTHS

100 HRS | 1,000 MI / 1,600 KM

- AIR FILTER INSPECT**
REPLACE AS NEEDED
- ALTERNATOR BELT INSPECT**
REPLACE AS NEEDED
- BATTERY TEST & CLEAN**
REPLACE AS NEEDED
- BRAKE PADS INSPECT**
REPLACE AS NEEDED
- DRIVE BELT INSPECT**
REPLACE AS NEEDED
- ENGINE OIL & OIL FILTER CHANGE**
- FRONT & REAR GEARCASE CHANGE FLUID**
- GENERAL LUBRICATION**
ALL FITTINGS, PIVOTS, CABLES, ETC.
- SPARK PLUGS INSPECT**
REPLACE AS NEEDED
- TRANSMISSION INSPECT FLUID**

18 MONTHS

150 HRS | 1,500 MI / 2,400 KM

- DRIVE BELT INSPECT**
REPLACE AS NEEDED
- AIR FILTER INSPECT**
REPLACE AS NEEDED
- BATTERY TEST & CLEAN**
REPLACE AS NEEDED
- GENERAL LUBRICATION**
ALL FITTINGS, PIVOTS, CABLES, ETC.

24 MONTHS

200 HRS | 2,000 MI / 3,200 KM

- AIR FILTER INSPECT**
REPLACE AS NEEDED
- ALTERNATOR BELT INSPECT**
REPLACE AS NEEDED
- BATTERY TEST & CLEAN**
REPLACE AS NEEDED
- BRAKE PADS INSPECT**
REPLACE AS NEEDED
- BRAKE FLUID CHANGE**
- DRIVE BELT INSPECT**
REPLACE AS NEEDED
- ENGINE OIL & OIL FILTER CHANGE**
- FRONT & REAR GEARCASE CHANGE FLUID**
- GENERAL LUBRICATION**
ALL FITTINGS, PIVOTS, CABLES, ETC.
- SPARK PLUGS INSPECT**
REPLACE AS NEEDED
- TRANSMISSION INSPECT FLUID**

30 MONTHS

250 HRS | 2,500 MI / 4,000 KM

- DRIVE BELT INSPECT**
REPLACE AS NEEDED
- AIR FILTER INSPECT**
REPLACE AS NEEDED
- BATTERY TEST & CLEAN**
REPLACE AS NEEDED
- GENERAL LUBRICATION**
ALL FITTINGS, PIVOTS, CABLES, ETC.
- BRAKE PADS INSPECT**
REPLACE AS NEEDED
- DRIVE BELT INSPECT**
REPLACE AS NEEDED
- AIR FILTER INSPECT**
REPLACE AS NEEDED
- ALTERNATOR BELT INSPECT**
REPLACE AS NEEDED
- BATTERY TEST & CLEAN**
REPLACE AS NEEDED
- BRAKE PADS INSPECT**
REPLACE AS NEEDED
- DRIVE BELT INSPECT**
REPLACE AS NEEDED
- ENGINE OIL & OIL FILTER CHANGE**
- FRONT & REAR GEARCASE CHANGE FLUID**
- GENERAL LUBRICATION**
ALL FITTINGS, PIVOTS, CABLES, ETC.
- SPARK PLUGS INSPECT**
REPLACE AS NEEDED
- TRANSMISSION INSPECT FLUID**

36 MONTHS

300 HRS | 3,000 MI / 4,800 KM

- AIR FILTER INSPECT**
REPLACE AS NEEDED
- ALTERNATOR BELT INSPECT**
REPLACE AS NEEDED
- BATTERY TEST & CLEAN**
REPLACE AS NEEDED
- BRAKE PADS INSPECT**
REPLACE AS NEEDED
- DRIVE BELT INSPECT**
REPLACE AS NEEDED
- ENGINE OIL & OIL FILTER CHANGE**
- FRONT & REAR GEARCASE CHANGE FLUID**
- GENERAL LUBRICATION**
ALL FITTINGS, PIVOTS, CABLES, ETC.
- SPARK PLUGS INSPECT**
REPLACE AS NEEDED
- TRANSMISSION INSPECT FLUID**

FOR A COMPLETE MAINTENANCE SCHEDULE, CHECK YOUR OWNER'S MANUAL

Claims made based off testing and performance of Polaris HD Parts against standard OEM parts made by Polaris and competitor brands under normal use. For more information regarding Polaris HD parts including vehicle compatibility, installation and maintenance, please contact your authorized Polaris ORV dealer.

SCRAMBLER 850 XP 1000 S



WINCHES



LEARN MORE P. 40



PRO HD SERIES

POLARIS PRO HD 1,588 KG WINCH

» 2883580
SCRAMBLER XP 1000 S '20-25

» 2889471
SCRAMBLER 850 '14-25,
SCRAMBLER XP 1000 '14-18

HD SERIES

POLARIS HD 1,588 KG WINCH

» 2889470
SCRAMBLER 850 '14-25, SCRAMBLER XP 1000 '14-18

HD SERIES

POLARIS HD 1,134 KG WINCH

» 2889469
SCRAMBLER 850 '14-25, SCRAMBLER XP 1000 '14-18

RACKS/STORAGE



LARGE REAR RACK

» 2879139
SCRAMBLER XP 1000 S '20-25, SCRAMBLER XP 1000 '14-18, SCRAMBLER 850 '14-25
NOT COMPATIBLE WITH OGIO BAG (2879925)



OGIO BAG

» 2879925
SCRAMBLER XP 1000 S '20-25, SCRAMBLER XP 1000 '14-18, SCRAMBLER 850 '14-25
NOT COMPATIBLE WITH LARGE REAR RACK (2879139)

PROTECTION

NEW ULTIMATE SPORT SERIES FRONT BRUSHGUARD

» 2883595-458
SCRAMBLER XP 1000 S '20-25



COMFORT



HANDGUARD

- Handguard Mount (2889341) is required when installing Polaris Handguards
- Does not fit with windshields

■ BRIGHT WHITE	2876883
■ BLACK TOP SELLER	2876846
■ INDY RED	2876845

» 2889341 • MOUNT



SCRAMBLER XP 1000 S '20-25,
SCRAMBLER 850 '14-25,
SCRAMBLER XP 1000 '14-18



ULTIMATE SERIES HANDGUARD KIT

- Protects riders from wind, snow, ice, branches, and other trail debris
- Larger design offers increased level of warmth and protection
- Ultimate Series Handguard Kit includes mounts

» 2890579-266
SCRAMBLER XP 1000 S '20-25, SCRAMBLER 850 '14-25, SCRAMBLER XP 1000 '14-18
NOT COMPATIBLE WITH WINDSHIELDS

MAINTENANCE PARTS & FLUIDS

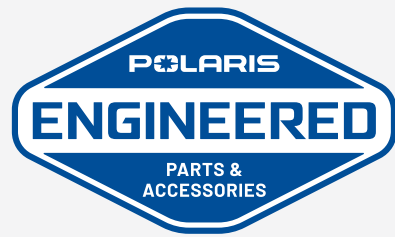

POLARIS ENGINEERED PARTS AND OIL have been validated and tested extensively, specifically for your vehicle. In order to maintain the peak performance of your Polaris vehicle only use official Polaris Engineered parts and oil.



We're taking the passion of our riders, workers, and outdoor enthusiasts to the next level with HD Parts. These Heavy Duty parts are engineered for riders who want greater durability and enhanced performance. HD Parts are designed and tested to handle greater wear and tear under all weather conditions.

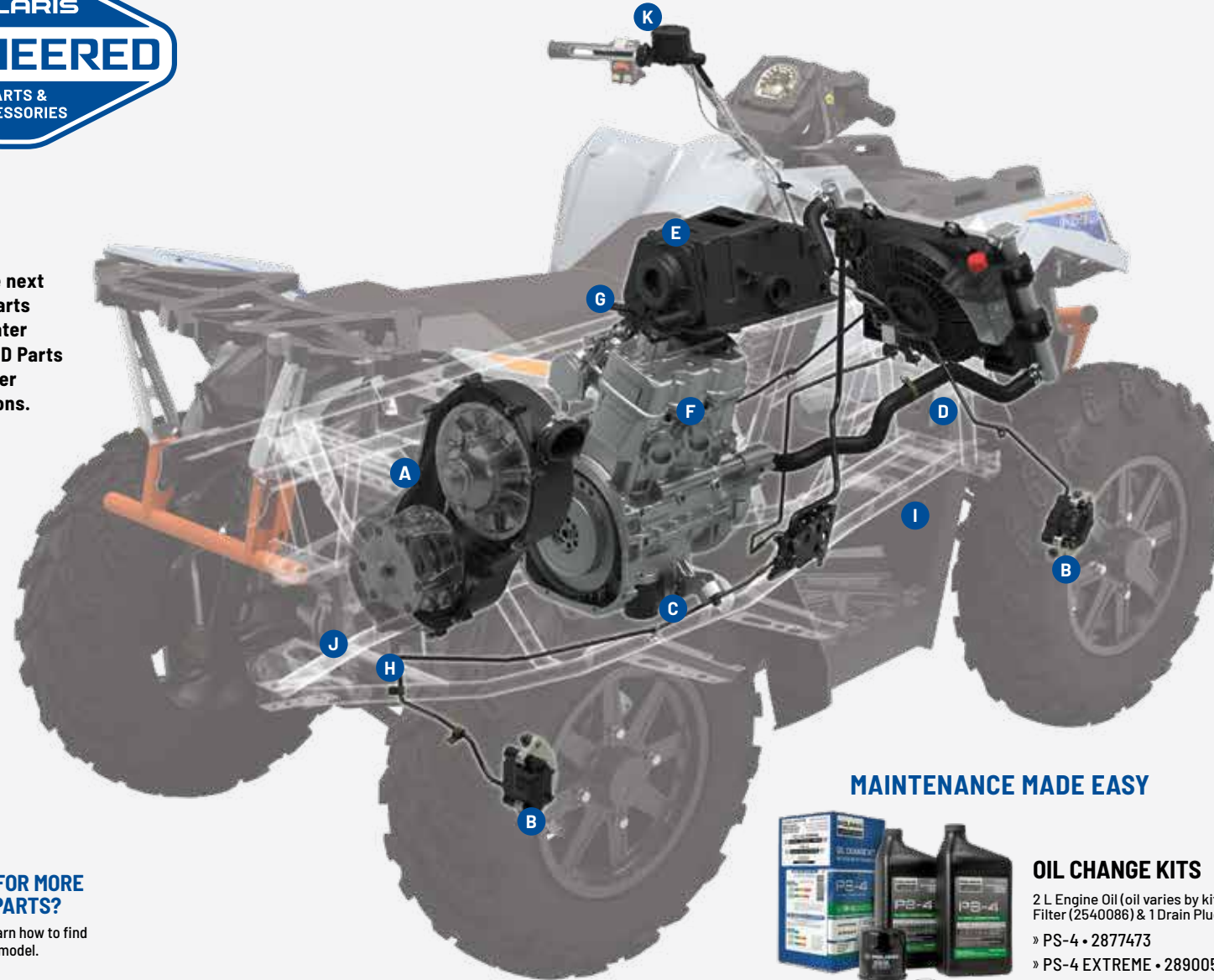

A DRIVE BELT
 » 3211160
 SCRAMBLER 850
 » 3212329
 SCRAMBLER XP 1000 S
 » **HD** • 3212331



B BRAKE PADS
 » FRONT • 2205606
 » REAR • 2208936



C OIL FILTER
 » 2520799
 » **HD** • 2522485



D BATTERY
 » 4014609



E AIR FILTER
 » 7082101
 » **HD** • 7082101



F SPARK PLUGS
 » 3022438
 SCRAMBLER 850
 » 3022553
 SCRAMBLER XP 1000 S

LOOKING FOR MORE SERVICE PARTS?
 See P. 69 to learn how to find parts for your model.

MAINTENANCE MADE EASY



OIL CHANGE KITS

2 L Engine Oil (oil varies by kit), 1 Oil Filter (2540086) & 1 Drain Plug Washer
 » PS-4 • 2877473
 » PS-4 EXTREME • 2890055



G ENGINE OIL P. 64
 » PS-4 • .95 L • 2876244
 » PS-4 • 3.8 L • 2876245
 » PS-4 EXTREME • .95 L • 2889395
 » PS-4 EXTREME • 3.8 L • 2889396



H ANGLE DRIVE FLUID
 For rear gearcase
 » .95 L • 2889280



I DEMAND DRIVE FLUID
 For front gearcase
 » .95 L • 2877922
 » 9.5 L • 2877923



J AGL
 For transmission
 » .95 L • 2878068
 » 3.8 L • 2878069
 » EXTREME • .95 L • 2891028



K DOT 4 BRAKE FLUID
 » 355 ML • 2872189



ALL-SEASON GREASE TUBE
 » 89 mL • 2871322
 » 414 mL • 2871423

Claims made based off testing and performance of Polaris HD Parts against standard OEM parts made by Polaris and competitor brands under normal use. For more information regarding Polaris HD parts including vehicle compatibility, installation and maintenance, please contact your authorized Polaris ORV dealer.

MAINTENANCE SCHEDULE*

BREAK-IN MAINTENANCE

FIRST 25 HRS | 250 MI / 400 KM

- ENGINE OIL & OIL FILTER CHANGE
- AIR FILTER INSPECT
REPLACE AS NEEDED
- FRONT & REAR GEARCASE CHANGE FLUID
- TRANSMISSION CHANGE FLUID

6 MONTHS

50 HRS | 500 MI / 800 KM

- BRAKE PADS INSPECT
REPLACE AS NEEDED
- AIR FILTER INSPECT
REPLACE AS NEEDED
- DRIVE BELT INSPECT
REPLACE AS NEEDED
- BATTERY TEST & CLEAN
REPLACE AS NEEDED
- GENERAL LUBRICATION ALL FITTINGS, PIVOTS, CABLES, ETC.

12 MONTHS

100 HRS | 1,000 MI / 1,600 KM

- AIR FILTER INSPECT
REPLACE AS NEEDED
- BRAKE PADS INSPECT
REPLACE AS NEEDED
- ENGINE OIL & OIL FILTER CHANGE
- FRONT & REAR GEARCASE CHANGE FLUID
- GENERAL LUBRICATION ALL FITTINGS, PIVOTS, CABLES, ETC.
- SPARK PLUGS INSPECT
REPLACE AS NEEDED
- TRANSMISSION CHANGE FLUID

18 MONTHS

150 HRS | 1,500 MI / 2,400 KM

- BRAKE PADS INSPECT
REPLACE AS NEEDED
- AIR FILTER INSPECT
REPLACE AS NEEDED
- DRIVE BELT INSPECT
REPLACE AS NEEDED
- BATTERY TEST & CLEAN
REPLACE AS NEEDED
- GENERAL LUBRICATION ALL FITTINGS, PIVOTS, CABLES, ETC.

24 MONTHS

200 HRS | 2,000 MI / 3,200 KM

- AIR FILTER INSPECT
REPLACE AS NEEDED
- BRAKE PADS / BRAKE FLUID INSPECT / CHANGE
REPLACE AS NEEDED / NA
- ENGINE OIL & OIL FILTER CHANGE
- FRONT & REAR GEARCASE CHANGE FLUID
- GENERAL LUBRICATION ALL FITTINGS, PIVOTS, CABLES, ETC.
- SPARK PLUGS INSPECT
REPLACE AS NEEDED
- TRANSMISSION CHANGE FLUID

30 MONTHS

250 HRS | 2,500 MI / 4,000 KM

- BRAKE PADS INSPECT
REPLACE AS NEEDED
- AIR FILTER INSPECT
REPLACE AS NEEDED
- DRIVE BELT INSPECT
REPLACE AS NEEDED
- BATTERY TEST & CLEAN
REPLACE AS NEEDED
- GENERAL LUBRICATION ALL FITTINGS, PIVOTS, CABLES, ETC.

36 MONTHS

300 HRS | 3,000 MI / 4,800 KM

- AIR FILTER INSPECT
REPLACE AS NEEDED
- BRAKE PADS INSPECT
REPLACE AS NEEDED
- ENGINE OIL & OIL FILTER CHANGE
- FRONT & REAR GEARCASE CHANGE FLUID
- GENERAL LUBRICATION ALL FITTINGS, PIVOTS, CABLES, ETC.
- SPARK PLUGS INSPECT
REPLACE AS NEEDED
- TRANSMISSION CHANGE FLUID

FOR A COMPLETE MAINTENANCE SCHEDULE, CHECK YOUR OWNER'S MANUAL

*This is a sample maintenance schedule. Please reference and use your owners manual for full maintenance and vehicle care.

MISCELLANEOUS ACCESSORIES



CHAINSAW MOUNT

- Heavy-duty, black powder-coated metal bracket is designed to transport your chain saw securely
- With Lock & Ride technology, it can be secured to the outside of the rack in seconds, without tools, so your chainsaw is within reach at all times
- Accommodates any brand electric chainsaw (sold separately)
- Rubber pads provide cushion and tight fit
- 15 lbs weight capacity

» 2890580

SPORTSMAN 450 H.O. '21-'25, SPORTSMAN 570 '21-'25, SPORTSMAN TOURING 570 '25



QUICKTAP BATTERY POSTS

- Easy-to-access terminal posts give you quick access to the battery power
- Ideal for charging your battery, powering a temporary accessory, or when you need to offer an unexpected jump-start
- Connection posts feature covers to protect terminals when not in use

» 2882110



ATV LICENSE PLATE

- Includes numbers and letters

» 2873270



RECOVERY STRAP

- 5cm x 9.1m (8165 kg)
- Comes with carry bag

» 2884033

TRAILERING AND ADDITIONAL STRAPS P. 60

SPORTSMAN YOUTH MAINTENANCE PARTS & FLUIDS



POLARIS ENGINEERED PARTS AND OIL have been validated and tested extensively, specifically for your vehicle. In order to maintain the peak performance of your Polaris vehicle only use official Polaris Engineered parts and oil.



DRIVE BELT

- » 3023904
OUTLAW 70 EFI
- » 0453455
OUTLAW 110, SPORTSMAN 110
- » 0452496
PHOENIX 200



BRAKE PADS

- » FRONT/REAR • 2208176
OUTLAW 70 EFI
- » FRONT • 0455315
OUTLAW 110, SPORTSMAN 110
- » REAR • 0455441
OUTLAW 110, SPORTSMAN 110
- » FRONT • 0454664
PHOENIX 200



OIL FILTER

- » 3023869
OUTLAW 70 EFI
- » 0452462
PHOENIX 200



BATTERY

- » 4010678
OUTLAW 70 EFI
- » 4011181
OUTLAW 110, SPORTSMAN 110
- » 4011434
PHOENIX 200



AIR FILTER

- » 7082513
OUTLAW 70 EFI
- » 0454620
OUTLAW 110, SPORTSMAN 110
- » 1253355
PHOENIX 200



SPARK PLUGS

- » 3023835
OUTLAW 70 EFI
- » 0453034
OUTLAW 110
- » 3023835
PHOENIX 200



ENGINE OIL

SEE P. 64 FOR DETAILS



ANGLE DRIVE FLUID

- » .95 L • 2889280
PHOENIX 200



AGL

- » .95 L • 2878068
- » 3.8 L • 2878069
- » EXTREME • .95 L • 2891028



DOT 4 BRAKE FLUID

- » 355 ML • 2872189



ALL-SEASON GREASE TUBE

- » 89 mL • 2871322
- » 414 mL • 2871423

YOUTH ATV OUTLAW 70 EFI

The perfect first all-terrain vehicle for kids starting at 6 years and older.



FRONT BRUSHGUARD

- Provides enhanced protection from brush and other debris on the trail

» 2884567

OUTLAW 70 EFI '21-'25



WINDSHIELD - POLY

- Added wind and hand protection with a durable poly design

» 2885005

OUTLAW 70 EFI '21-'25



REAR BRUSHGUARD

- Protect the rear of your youth ATV on the trails

» 2884778

OUTLAW 70 EFI '21-'25



REAR STORAGE BAG

- Convenient storage that easily connects to the rear rack

» 2884555

OUTLAW 70 EFI '21-'25

MAINTENANCE SCHEDULE*

BREAK-IN MAINTENANCE

FIRST 10 HRS | 100 MI / 160 KM

- AIR FILTER INSPECT & CLEAN
REPLACE AS NEEDED
- ENGINE OIL & FILTER CHANGE
- TRANSMISSION OIL CHANGE
- DRIVE CHAIN ADJUST & LUBRICATE

1 MONTH

20 HRS | 200 MI / 320 KM

- BATTERY CLEAN & TEST
- ENGINE OIL & FILTER CHANGE

6 MONTHS

50 HRS | 500 MI / 800 KM

- GENERAL LUBRICATION ALL FITTINGS, PIVOTS, CABLES, ETC.
- BRAKE PADS INSPECT
REPLACE AS NEEDED
- DRIVE BELT INSPECT
REPLACE AS NEEDED

8 MONTHS

60 HRS | 700 MI / 1000 KM

- AIR FILTER INSPECT & CLEAN
REPLACE AS NEEDED
- SPARK PLUG INSPECT & CLEAN
REPLACE AS NEEDED

12 MONTHS

100 HRS | 1000 MI / 1600 KM

- TRANSMISSION OIL CHANGE
- DRIVE BELT INSPECT
REPLACE AS NEEDED

FOR A COMPLETE MAINTENANCE SCHEDULE, CHECK YOUR OWNER'S MANUAL

*This is a sample maintenance schedule. Please reference and use your owners manual for full maintenance and vehicle care.

WINCHES



ADD A PLOW
P. 42



TOP-OF-THE-LINE FEATURES
BEST FOR PLOWING, HEAVY-DUTY OUTDOOR CHORES & TRAIL RIDING



BUILT FOR THE OFF-ROAD
BEST FOR THE CASUAL OFF-ROAD RIDER

DEPENDABLE. TOUGH. BUILT FOR THE OFF-ROAD.

A Polaris Engineered winch is designed to help you get the job done right, get you on your way faster and prepare you for the unexpected.

WHY POLARIS?

Polaris Off Road vehicles are engineered with designated mounting points and wiring for seamless install of Polaris Engineered winches.



TESTED **1,200+**
PULLS AT MAX LOAD



BUILT TO WITHSTAND
-29° C TEMPERATURES



OPERATES
FULLY SUBMERGED



MILITARY
TESTED & APPROVED



TOP SELLER
REPLACEMENT SYNTHETIC ROPE
» 2,500 LB • 2878888



REPLACEMENT STEEL CABLE
• 1588 kg LB winch series - 15.2 m
» 2878890

FEATURES & BENEFITS

ALL POLARIS ENGINEERED WINCHES COME WITH:

- ✓ **INTEGRATED WIRING, MOUNT, PREASSEMBLED**
- ✓ **HOOK WITH STRAP**
- ✓ **CUT STEEL GEARS & SEALED DRIVETRAIN**
- ✓ **SEALED PERMANENT MAGNET MOTOR**

RAPID ROPE RECOVERY



Retrieve cable 5x as fast as standard mode on other Polaris winches. Get back to riding or complete your task quicker.

1. Set winch dial to N (Neutral) to manually pull the rope out and secure the hook to your anchor point
2. Set winch dial to L (Low) for maximum pulling power while winching your load
3. Set winch dial to H (High) for retrieving the rope 5x faster with Rapid Rope Recovery

AUTO STOP TECHNOLOGY

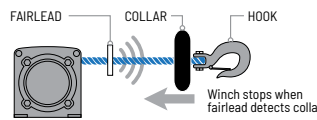

Auto Stop technology protects and extends the life of your winch by automatically stopping the winch at the end of pull to prevent over-spooling. While plowing, it prevents the plow frame from bending by stopping the winch once the plow has been lifted.

PREMIUM SYNTHETIC ROPE



With its lightweight, yet extremely strong, design and superior flexibility, this 15.2 m long synthetic rope is easy to handle and can stand up to any tough job.

WIRELESS REMOTE

This convenient remote operates your Polaris winch wirelessly from within 15.2 m of the vehicle. Operate your winch safely outside your vehicle while on the job site or trails.

PRO HD SERIES

HD SERIES

FEATURES & BENEFITS	PRO HD SERIES	HD SERIES
ALL POLARIS ENGINEERED WINCHES COME WITH:	✓	✓
INTEGRATED WIRING, MOUNT, PREASSEMBLED	✓	✓
HOOK WITH STRAP	✓	✓
CUT STEEL GEARS & SEALED DRIVETRAIN	✓	✓
SEALED PERMANENT MAGNET MOTOR	✓	✓
RAPID ROPE RECOVERY	✓	NOT AVAILABLE
AUTO STOP TECHNOLOGY	✓	<p>ADD AUTO STOP TECHNOLOGY</p> <div style="display: flex; justify-content: space-around;"> <div style="text-align: center;">  <p>2881693 SYNTHETIC ROPE REQUIRED FITS WINCHES: 2880434, 2880432</p> </div> <div style="text-align: center;">  <p>2889253 SYNTHETIC ROPE REQUIRED FITS WINCHES: 2884832, 2884833, 2889469, 2889470</p> </div> </div>
PREMIUM SYNTHETIC ROPE	✓	<p>TOP SELLER ADD SYNTHETIC ROPE 2878888</p>
WIRELESS REMOTE	✓	<p>ADD WIRELESS WINCH REMOTE 2879316</p>

MODEL	1588 KG WITH SYNTHETIC ROPE	1588 KG WITH SYNTHETIC ROPE	1134 KG WITH STEEL CABLE
450 H.O. '21-25 570 '21-25 X2 570 '25 TOURING 570 '25 6X6 570 '25	TOP SELLER 2884834	TOP SELLER 2884833	TOP SELLER 2884832
850 '12-25 XP 1000 '15-25 TOURING XP 1000 '15-25 TOURING 850 '15-25 SCRAMBLER 850 '14-25	2889471	2889470	2889469
XP 1000 S '20-25 SCRAMBLER XP 1000 S '20-25	2883580		

GLACIER PLOW SYSTEMS

TAKE COMMAND OF CLEARING SNOW AND MAKE QUICK WORK OF EVEN THE HEAVIEST JOBS.



INSTALLATION

30 seconds: drive up, hook on, lock down, and go – the integrated Polaris Engineered Glacier Plow System simplifies plowing.

ROBUST FRAME

A plow system is only as strong as its frame, and Polaris Engineered plow frames have a wide frame to withstand the rigors of heavy plowing.



DURABLE BLADES

Available in strong stamped steel or corrosion-resistant poly materials, Polaris Engineered plow blades cover a large surface area for quick snow removal.

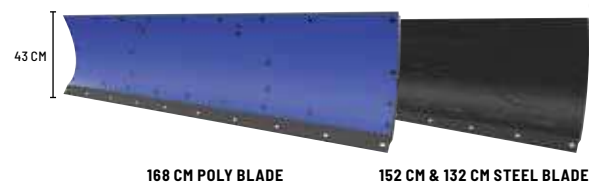

CONVENIENCE

Lift and angle adjustments can be made from the driver's seat.



PLOW SYSTEMS (WINCH REQUIRED, SOLD SEPARATELY)

Choose a Glacier Plow System, designed to help you get the most out of your Sportsman during snowy months. Select a system based on your plowing needs with premium add-ons including a hydraulic lift system or additional plow accessories.

GLACIER PRO HD PLOW SYSTEM WITH HYDRAULICS

- System includes:
- Mount (2881424)
 - Frame (2879630)
 - 167.64 cm Poly Plow (2880269)
 - Hydraulic Angle (2879635)
 - Plow Markers (2872726)
 - Plow Deflector (2879866)
- » 3880010
- 450 '15-25, 570 '15-25, 6X6 570 '17-25, X2 570 '15-23, X2 570 '25, TOURING 570 '15-25
REQUIRES LIFT METHOD: SEE WINCHES BELOW

GLACIER PRO HD PLOW SYSTEM

- System includes:
- Mount (2881424)
 - Frame (2879630)
 - 152.4 cm Steel Plow (2879638)
- » 3880011
- 450 '15-25, 570 '15-25, 6X6 570 '17-25, X2 570 '15-23, X2 570 '25, TOURING 570 '15-22
REQUIRES LIFT METHOD: SEE WINCHES BELOW

GLACIER PRO HD PLOW SYSTEM WITH HYDRAULICS

- System includes:
- Mount (2881423)
 - Frame (2879630)
 - 167.64 cm Poly Plow (2880269)
 - Hydraulic Angle (2879635)
 - Plow Markers (2872726)
 - Plow Deflector (2879866)
- » 3880012
- XP 1000 '15-25, 850 '15-25, TOURING 1000 '15-25, TOURING 850 '15-25, SCRAMBLER 850 '15-25
REQUIRES LIFT METHOD: SEE WINCHES BELOW

GLACIER PRO HD PLOW SYSTEM

- System includes:
- Mount (2881423)
 - Frame (2879630)
 - 152.4 cm Steel Plow (2879638)
- » 3880013
- XP 1000 '15-25, 850 '15-25, TOURING 1000 '15-25, TOURING 850 '15-25, SCRAMBLER 850 '15-25
REQUIRES LIFT METHOD: SEE WINCHES BELOW



GLACIER PLOW SYSTEMS

168 cm, 152 cm or 132 cm blades

Choice of poly or steel

Ability to add a hydraulic angle system

MODELS	MANDATORY STEPS			OPTIONAL	
	STEP 1 SELECT A MOUNT	STEP 2 SELECT A FRAME	STEP 3 SELECT PLOW CONFIGURATION	BLADES	STEP 4 ADD HYDRAULICS
XP 1000 '15-25 850 '15-25 850/XP 1000 HIGHLIFTER '16-25 TOURING XP 1000 '15-25 TOURING 850 '10-25 SCRAMBLER 850 '14-25	TOP SELLER 2881423		Polaris Pro HD 1,588 kg Winch 2889471 Polaris HD 1,588 kg Winch 2889470 Polaris HD 1,134 kg Winch 2889469		
XP 1000 S '20-25 SCRAMBLER XP 1000 S '20-25	2883581		Polaris Pro HD 1,588 kg Winch 2883580	168 cm Poly 2880269	
6X6 570 '17-25 X2 570 '15-25 TOURING 570 '15-25		TOP SELLER 2879630	TOP SELLER Polaris HD 1,588 kg Winch 2880434 TOP SELLER Polaris HD 1,134 kg Winch 2880432	TOP SELLER 152 cm Steel 2879638 TOP SELLER 132 cm Steel 2879639	Hydraulic Plow Blade Angle System 2879635
570 '15-25 450 H.O. '16-25 6X6 570 '25 X2 570 '25 TOURING 570 '25	TOP SELLER 2881424		TOP SELLER Polaris Pro HD 1,588 kg Winch 2884834 TOP SELLER Polaris HD 1,588 kg Winch 2884833 TOP SELLER Polaris HD 1,588 kg Winch 2884832		
STEP 5 SELECT ACCESSORIES AND REPLACEMENT ITEMS					
168 cm HD Wear Bar 2879868 168 cm Wear Bar 2879867 152 cm Wear Bar 2877243 132 cm Wear Bar 2877210 152 cm UHMW Wear Bar 2890651 132 cm UHMW Wear Bar 2890652	168 cm Plow Blade Snow Deflector 2879866 152 cm Plow Blade Deflector 2871808 Skid Shoe 2208864 Glacier Pro Shear Pin Replacement 2205063 Coil Spring Spacer 2872655	Plow Winch Rope (for 1,134 kg & 1,588 kg winches) 2878483 Glacier Plow Marker (sold in pairs) 2872726 Rear Tire Chains (recommended for rear tires only) 2881422 Plow Blade Track Extension (required for track equipped vehicles) 2879719			

BUILD A PLOW SYSTEM

ACCESSORIES

450 / 570

850 / XP 1000
XP 1000 S

SCRAMBLER 850 /
XP 1000 S

MISCELLANEOUS
& YOUTH

WINCHES PLOWS
& TRACKS

LIGHTING

CONNECTED
TECHNOLOGY

HUNT & COOLERS

WHEELS & TIRES
& TRAILERING

ALL-TERRAIN TRACTION

It's tough to make Sportsman even more versatile than it already is. But with a set of Prospector Pro Tracks, you'll do just that. Tread through deep snow without concern.

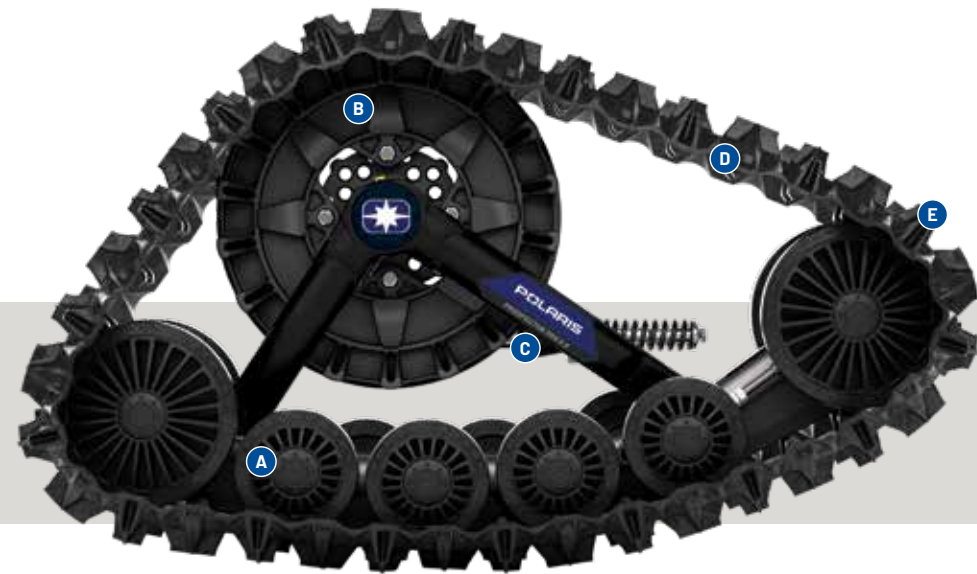

PROSPECTOR PRO 2.0 TRACK SYSTEM

- A** New front dual stabilizer for improved stability
- B** Polaris-specific gearing provides 1:1 ratio to:
 - Minimize track slip, providing better climbing ability and improved traction in deep snow
 - Improve top speed over prior models by approximately 5%
 - Reduce operating RPM for a quieter ride
 - Improve driveline durability, which allows vehicle to run at a lower RPM, decreasing engine wear
- C** Polaris exclusive optimized hub geometry that minimizes feedback and eases steering effort
- D** Lightweight design provides for better flotation, eases steering effort, and provides better vehicle control
- E** Flexible lug design provides the highest level of deep snow performance by lifting up in deep snow as opposed to digging down

STEP 1 SELECT A MOUNT KIT		
MODELS	A-ARMS	MOUNT KIT
XP 1000/850 '15-25 TOURING XP 1000/850 '15-25	STRAIGHT	2879457
XP 1000/850 '16-25 HIGHLIFTER 1000/850 '16-25	ARCHED	2882109
XP 1000 S '20-25 SCRAMBLER XP 1000 S '20-25	ARCHED	2883977
570 '21-25 X2 570 '25 TOURING 570 '25	ARCHED	2889218
450/570 '21-25 X2 570 '25 TOURING 570 '25	STRAIGHT	2889219
450/570 '14-20 TOURING 570 '15-24 X2 570 '15-21	STRAIGHT	2879497

STEP 2 SELECT A TRACK KIT	
MODELS	TRACK KIT
450/570 '14-25 TOURING 570 '15-23 X2 570 '15-23 X2 570 '25 TOURING 570 '25	2889493
XP 1000 '15-25 850 '15-25 TOURING XP 1000/850 '17-25 HIGHLIFTER 1000 '16-25 XP 1000 S '20-25 SCRAMBLER XP 1000 S '20-25 SCRAMBLER 850 '13-25	2889495

WANT TO PLOW?

GLACIER PRO PLOW TRACK EXTENSION

- Plow extension for use when using the Prospector Pro Track System and Glacier Pro Plow System

» 2879719

FOR USE WITH GLACIER PRO PLOW SYSTEMS

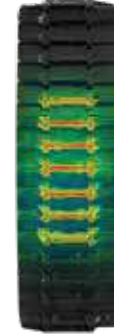

SPORTSMAN SNOW TRACTION OPTIONS

TREAD THROUGH SNOW WITH THESE OPTIONS	CONTACT PATCH	TURNING RADIUS
 <p>STOCK TIRES</p>	<p>GOOD</p> 	<p>354.3 CM</p> 
 <p>PRO ARMOR WHITEOUT</p>	<p>BETTER</p>  <p>More surface area for better flotation on snow</p>	<p>352.743 CM</p> 
 <p>PROSPECTOR PRO 2.0 TRACKS</p>	<p>BEST</p>  <p>Less aggressive tread displaces snow for better handling</p>	<p>445.453 CM</p> 

CONNECTED TECHNOLOGY

GO REMOTE.
STAY CONNECTED.

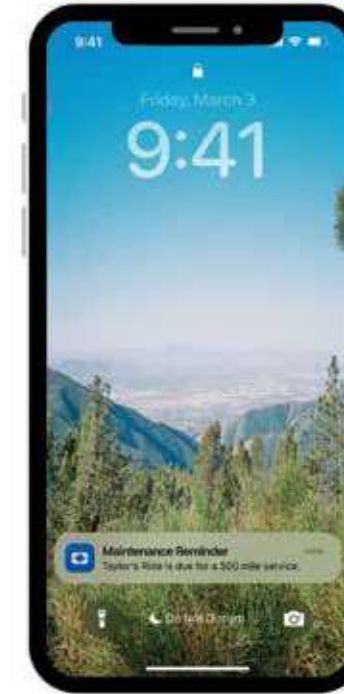
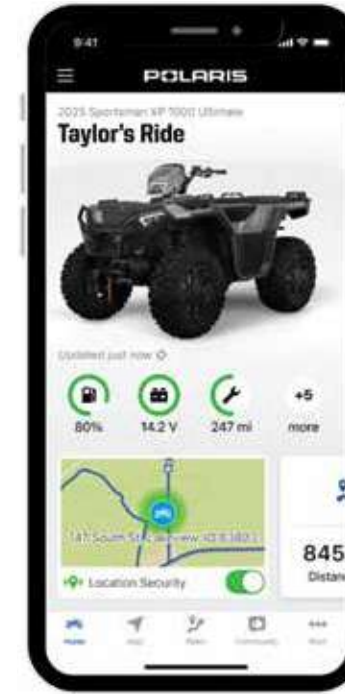

	POLARIS RIDECOMMAND	POLARIS RIDECOMMAND+
VEHICLE OWNERSHIP	GARAGE	✓
	WARRANTY STATUS	✓
	MAINTENANCE REMINDERS	✓
	ISSUE DIAGNOSTICS	✓
RIDING FEATURES	VEHICLE HEALTH	✓
	COMMUNITY	✓
	CONTENT SHARING	✓
	RIDE PLANNING	✓
	WAYPOINTS	✓
SECURITY	RIDE TRACKING	✓
	RIDE TRACKING+	✓
	GROUP RIDE	✓
VEHICLE HEALTH	GROUP RIDE+	✓
	VEHICLE LOCATOR	✓
	LOCATION ALERTS	✓
	CHECK-IN MESSAGES	✓

POLARIS RIDECOMMAND

PLAN YOUR RIDE

Plan an epic ride with stops along the way and ensure you're on a marked trail with Snap-to-Trail technology. Later, share your route with friends so you can hit the trails together.

FOLLOW THE GROUP

With patented Group Ride technology, you can ride at your own speed and keep fellow riders in sight on your map screen, even if you get split up. Because rides are meant to be shared.

WORK SMARTER

Plow Mode automatically raises and lowers the plow depending on the gear you're in so that you can get your work done quicker.

DISCOVER NEW TRAILS

With over 1,000,000 miles of trails available offline, you'll have the confidence to explore further, whether you have cellular coverage or not.

POLARIS RIDECOMMAND+

THE LATEST IN INDUSTRY-LEADING CONNECTED VEHICLE TECHNOLOGY

Stay connected to your Sportsman from anywhere with vehicle telematics shared directly to the palm of your hand.



LOCATION ALERTS



VEHICLE HEALTH



RIDE TRACKING+ & GROUP RIDE+



ISSUE DIAGNOSTICS



MAINTENANCE REMINDERS

AVAILABLE ON RIDE COMMAND EDITION/ULTIMATE MODELS & AS AN ACCESSORY 7" DISPLAY POWERED BY RIDE COMMAND

Industry-leading 7" display with glove-touch compatibility and visible in all conditions.

Configurable Gauges
Customize your ride experience with elevation, travel direction, fuel level and more to create relevant screens for you.

» 2889455

SPORTSMAN 450/570 '22-25, SPORTSMAN 850/1000 '22-25, X2 570 '25, 6X6 570 '25, TOURING 570 '25

Personalized Audio Experience
Seamlessly pair to your display via Bluetooth to wirelessly stream music and stay connected with call and text alerts. Add the Lock & Ride Rear Audio Storage Box to stream music. (Requires Lock & Ride Rear Audio Storage Box and Rear Power Harness.)

Industry-Exclusive Plow Mode
Quick and easy plowing. Plow automatically lowers when shifted into low gear and raises when shifted into reverse. (Requires Polaris Winch with Auto Stop Technology and Synthetic Rope. Learn more on P. 40)

7" Display Mount Kit Included
Comes with required wiring harnesses and accessory components. Includes V2V and GPS antenna.

AVAILABLE ON SELECT 2023 & NEWER MODELS RIDE COMMAND+ CONNECTED VEHICLE ACCESSORIES*

NEW
» 3880083

SPORTSMAN 850 '23-25, SPORTSMAN 1000 '23-25, SPORTSMAN XP 1000 '23-25
INCLUDES ALL TRIMS & RIDE COMMAND EDITIONS

NEW
» 3880081

SPORTSMAN 570 '23-25
INCLUDES ALL TRIMS & RIDE COMMAND EDITIONS

NEW
» 3880082

SPORTSMAN 450/570 '23-25
INCLUDES ALL TRIMS, RIDE COMMAND EDITIONS AND TOURING MODELS

*Kits includes all necessary accessories to activate RIDE COMMAND+

LEARN MORE AND DOWNLOAD AT
[RIDECOMMAND.POLARIS.COM](https://www.polaris.com/ridecommand)



HUNT

KOLPIN[®] OUTDOORS

PROTECTING YOUR ESSENTIAL GEAR SINCE 1943



KOLPIN STRONGHOLD SYSTEM

Polaris is proud to partner with Kolpin Outdoors, an industry leader in off-road accessories and the premier name in gun boots and mounts. If you need to secure a firearm while riding, simply attach the auto-latch mount and choose your gun boot.

IDEAL FOR SECURE TRANSPORT OF SCOPED RIFLES AND SHOTGUNS.

STEP 1 CHOOSE YOUR MOUNT

STEP 2 CHOOSE YOUR BOOT



KOLPIN STRONGHOLD AUTO-LATCH MOUNT

- The auto-latch provides quick and secure attachment of Kolpin Stronghold Gun Boots
- Bracket is made from rugged high impact, reinforced nylon and coated steel with precision angle adjustment for a custom fit
- For use with Kolpin Stronghold Gun Boots (sold separately)

» 2882272
SPORTSMAN 850/1000 '17-25
DOES NOT FIT WITH ULTIMATE SERIES BODY ARMOR (2882090)



KOLPIN STRONGHOLD AUTO-LATCH MOUNT

- The Auto-Latch provides quick and secure attachment of Kolpin Stronghold Gun Boots
- Bracket is made from rugged high impact, reinforced nylon and coated steel with precision angle adjustment for a custom fit
- For use with Kolpin Stronghold Gun Boots (sold separately)

» 2884846
TOURING 570 '25, SPORTSMAN TOURING 570 '25,
SPORTSMAN 450/570 '21-25



KOLPIN STRONGHOLD GUN BOOT L

- 132.1 cm L x 12.1 cm W x 23.5 cm H
- Requires Auto-Latch Mount 2882272 or 2884846 to mount to vehicle

» 2882426
SPORTSMAN 850/1000 '17-25, TOURING 570 '25,
SPORTSMAN 450/570 '14-25



KOLPIN STRONGHOLD GUN BOOT XL

- Lockable and TSA Approved
- Includes padded, zippered internal protective liner
- 132.1 cm L x 9.5 cm W x 26.6 cm H
- Requires Auto-Latch Mount 2882272 or 2884846 to mount to vehicle

» 2882036
XP 1000 '17-25, 850 '17-25, TOURING 570 '25, 570 '19-25, 450 H.O. '21-25



KOLPIN RHINO GRIPS

IDEAL FOR CARRYING RIFLES,
SHOTGUNS, BOWS AND CROSSBOWS.

RHINO GRIP PRO - ATV

- » 2884119
- » REPLACEMENT RUBBER STRAPS • 2884109
ALL SPORTSMAN MODELS (EXCEPT UTILITY EDITIONS & YOUTH)



RATCHETING RHINO GRIP - ATV

- » 2881157
ALL SPORTSMAN MODELS (EXCEPT UTILITY AND YOUTH)



RHINO GRIP XLR - ATV

- » 2889147
- » REPLACEMENT RUBBER STRAPS (2) • 2889204
ALL SPORTSMAN MODELS
(EXCEPT UTILITY EDITIONS & YOUTH)



RHINO GRIP XLR - DOUBLES - ATV

- » 2889148
- » REPLACEMENT RUBBER STRAPS (2) • 2889204
ALL SPORTSMAN MODELS
(EXCEPT UTILITY EDITIONS & YOUTH)



All Kolpin Rhino Grips are Lock & Ride compatible and come with required mounting hardware.

ADDITIONAL STORAGE OPTIONS

KOLPIN GUN BOOT IV

- For 50mm scopes, rifles with slings attached, or shotguns up to 129.54 cm in length

» BLACK • 2872677
REQUIRES MOUNT 2878001 TO MOUNT TO SPECIFIC SPORTSMAN MODELS



GUN BOOT MOUNTS

- Works with Lock & Ride XL Storage Box, Lock & Ride Rear Cargo Box, and Rear Rack Extenders

» 2878001
SPORTSMAN 850/1000 TOURING '10-25
ONLY COMPATIBLE WITH KOLPIN GUN BOOT IV - NOT COMPATIBLE
WITH KOLPIN STRONGHOLD GUN BOOTS



ACCESSORIES

450 / 570

850 / XP 1000
XP 1000 S

SCRAMBLER 850 /
XP 1000 S

MISCELLANEOUS
& YOUTH

WINCHES, PLOW
& TRACKS

LIGHTING

CONNECTED
TECHNOLOGY

HUNT & COOLERS
& TRAILERING

WHEELS & TIRES
& TRAILERING

51

COOLERS

MADE FOR RIDERS.
BUILT FOR LIFE.



28, 57 & 99
LITER FEATURES



ComfortCarry
Handles



TravelLock
System



EasyOut
Drain System



NoSlip
Rubber Feet



PolarWall
Insulation



IceLock
Seal

POLARIS NORTHSTAR COOLERS CAN SURVIVE JUST ABOUT ANYTHING -
FROM EXTREME HEAT TO A NASTY TUMBLE OFF A VEHICLE.



99 LITER

SAGEBRUSH GREEN • 2890707
GRAPHITE • 2883426

ACCESSORIES

WIRE BASKET • 2883648
DIVIDER (1) • 2883468
WHEELS • 2883967

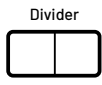

1 way to
partition



57 LITER

SAGEBRUSH GREEN • 2890706
GRAPHITE • 2883425

ACCESSORIES

WIRE BASKET • 2882185
DIVIDERS (2) • 2882184
SEAT CUSHION • 2882179
WHEELS • 2882180



2 ways to
partition



28 LITER

SAGEBRUSH GREEN • 2890705
GRAPHITE • 2883424

ACCESSORIES

WIRE BASKET • 2882438
DIVIDER (1) • 2882186



1 way to
partition



14 LITER

SAGEBRUSH GREEN • 2890704
GRAPHITE • 2883968



19 LITER
SOFT-SIDED COOLER

GRAPHITE • 2889285



HOLDS ICE FOR AGES

BECAUSE JUST ANY COOLER
WON'T CUT IT OUT THERE.

You need something rugged and reliable. A cooler purpose-built to handle the challenges of the off-road—while keeping your provisions on ice for days on end. Because out here, there are no ice machines, and you just left the last one in your dust. So, load it up. Lock it in. And know your NorthStar cooler is staying put—giving you a few extra days of ice time to enjoy the wild.

ESSENTIAL ACCESSORIES SO YOUR COOLER WORKS AS HARD AS YOU DO

WIRE BASKET



DIVIDERS Doubles as cutting board



SEAT CUSHION



WHEELS



TUMBLER

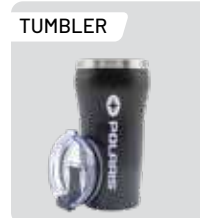

591 ML • 2883393

WHEELS & TIRES



PRO ARMOR

OFF-ROAD, IT'S ALL ABOUT FREEDOM & CREATING YOUR OWN PATH

As serious riders ourselves, we get it. And everything we design is to get (and keep) you going on the ride of a lifetime. We're for every style of rider looking to go beyond the expected with a ride that will make your story epic.



WHY CHOOSE PRO ARMOR?

SUPERIOR PERFORMANCE & DURABILITY

LIFELONG PERFORMANCE

- Every tire is designed and constructed with **longevity** in mind
- **3,000+ mile rated** (4,828 kilometers)

PREMIUM PROTECTION

- Pro Armor makes tires with **extra protection** exactly where it's needed most – the sidewall
- **Triple-belted sidewalls** keep your tires more resistant so you can keep going. Many competitors only use double-belted sidewalls

TOUGH TIRES

- Higher ply ratings mean added protection
- Pro Armor builds 8 or 10-ply rated tires for **higher puncture-resistance**



ACCESSORIES

450 / 570

850 / XP1000
XP1000 S

SCRAMBLER 950 /
XP1000 S

MISCELLANEOUS
& YOUTH

WINCHES, PLOWS
& TRACKS

LIGHTING

CONNECTED
TECHNOLOGY

HUNT & COOLERS

WHEELS & TIRES
& TRAILERING

TIRES

Developed and tested with Polaris engineers, ensuring the perfect fit and optimal performance mile after mile.



12"
14"
WHEEL

PRO ARMOR PRESERVE

Turf-friendly for areas requiring low-impact from treads.

Why Choose Preserve?
Perfect for locations where you don't want to risk damaging turf.



12"
WHEEL

PRO ARMOR XD-K

These heavy duty tires are one of the strongest we've ever built. Superior puncture resistance, ride quality and long life.

Why Choose XD-K?
Triple-belted sidewall resists puncture.



12"
14"
WHEEL

PRO ARMOR HARVESTER

Designed for trail & agricultural applications with excellent grip, minimal crop impact and long wear life.

Why Choose Harvester?
Great for unexpected impact and rugged terrain.



14"
WHEEL

PRO ARMOR X TERRAIN

Handle anything the trail throws your way, with a durability-driven design that provides a comfortable and confident ride.

Why Choose X Terrain?
Triple-belted sidewall resists puncture.



12"
14"
WHEEL

PRO ARMOR TREKKER

The best balance of on-trail handling and low tire noise.

Why Choose Trekker?
Ultimate predictability with a quiet ride.



14"
WHEEL

DUAL-DUROMETER

PRO ARMOR DUAL-THREAT

Dual compound technology for superior grip and traction.

Why Choose Dual-Threat?
Softer outer lugs for cornering grip and feel; harder inner lugs for longer tread life.



14"
WHEEL

PRO ARMOR ATTACK

Aggressive tread design provides traction in any environment.

Why Choose Attack?
Great all-season tire with wider lug spacing for grip in softer terrain.



14"
WHEEL

PRO ARMOR WHITEOUT

Engineered to charge through snow with unprecedented flotation and traction.

Why Choose Whiteout?
More surface area for better flotation on snow.



14"
WHEEL

DUAL-COMPOUND

PRO ARMOR MUD XC

The best tread design that balances aggressive traction in the mud with a smoother ride on the trail.

Why Choose Mud XC?
Perfect mud-trail crossover.



PRO ARMOR TIRES HAVE BEEN DEVELOPED AND TESTED to ensure the perfect fit, superior durability and optimal performance, mile-after-mile. No matter where you ride - mud, dirt, sand or snow - we've got you covered.

KNOW YOUR TERRAIN



- Tread patterns optimized for extreme traction
- Ideal for both hard pack & loose trail



- Provides traction & durability
- Performs in hard sand, jagged rocks or any extreme terrain



- Flexible "grippy" tread
- Aggressive side bite



- Extra deep treads
- Self-cleaning lugs



- Triple-belted sidewalls to resist puncture
- Purpose-built, long lasting tread patterns



- Handles extreme cold
- Holds shape & provides traction

WHEELS



14" 40-SERIES

A 4101 ○

WEIGHT: 6.6 kg LOAD RATING: 363 kg OFFSET: -35
 MATTE BLACK FRONT/REAR 14" x 10" 1522958

B 4201 ○

FRONT WEIGHT: 5.9 kg LOAD RATING: 408 kg OFFSET: +9
 REAR WEIGHT: 6.4 kg LOAD RATING: 590 kg OFFSET: +9
 ACCENT FRONT 14" x 7" 1522956-266
 REAR 14" x 8" 1522957-266
 MATTE BLACK FRONT 14" x 7" 1522956-458
 REAR 14" x 8" 1522957-458

C 4202 ○

FRONT WEIGHT: 5.8 kg LOAD RATING: 408 kg OFFSET: +4
 REAR WEIGHT: 6.1 kg LOAD RATING: 590 kg OFFSET: -9
 ACCENT FRONT 14" x 7" 1522544-266
 REAR 14" x 8" 1522545-266
 MATTE BLACK FRONT 14" x 7" 1522544-458
 REAR 14" x 8" 1522545-458

D 4203 BEADLOCK ○

FRONT WEIGHT: 5.9 kg LOAD RATING: 408 kg OFFSET: +4
 REAR WEIGHT: 6.6 kg LOAD RATING: 590 kg OFFSET: -9
 MATTE BLACK FRONT 14" x 7" 1522238-458
 REAR 14" x 8" 1522239-458

E 4204 ○

FRONT WEIGHT: 5.9 kg LOAD RATING: 408 kg OFFSET: +4
 REAR WEIGHT: 6.4 kg LOAD RATING: 590 kg OFFSET: -9
 ACCENT FRONT 14" x 7" 1522546-266
 REAR 14" x 8" 1522547-266
 MATTE BLACK FRONT 14" x 7" 1522546-458
 REAR 14" x 8" 1522547-458

F 4205 ○

FRONT WEIGHT: 4.8 kg LOAD RATING: 408 kg OFFSET: +4
 REAR WEIGHT: 5.7 kg LOAD RATING: 590 kg OFFSET: -9
 MATTE BLACK FRONT 14" x 7" 1521507-521
 REAR 14" x 8" 1521508-521
 LUSTER FRONT 14" x 7" 1521507-410
 REAR 14" x 8" 1521508-410

G 4206 ○

FRONT WEIGHT: 4.3 kg LOAD RATING: 408 kg OFFSET: +4
 REAR WEIGHT: 4.9 kg LOAD RATING: 590 kg OFFSET: -9
 MATTE BLACK FRONT 14" x 6" 1522542-458
 REAR 14" x 8" 1522543-458

H 4301 BEADLOCK

WEIGHT: 7.3 kg LOAD RATING: 726 kg OFFSET: +38
 ACCENT FRONT/REAR 14" x 7" 1523284
 MATTE BLACK FRONT/REAR 14" x 7" 1523283

I HD DUAL BEADLOCK ○

WEIGHT: 18.1 kg LOAD RATING: 725.7 kg OFFSET: +38
 MATTE BLACK FRONT/REAR 14" x 7" 1524022-458

14" FORGED BEADLOCK RINGS

MACHINED 1522244-266

ONLY USED ON 4203 BEADLOCK & HD DUAL BEADLOCK SOLD INDIVIDUALLY

MATTE BLACK 1523146-458

ONLY USED ON 4301 BEADLOCK & HD DUAL BEADLOCK SOLD INDIVIDUALLY



2 WAYS TO PURCHASE

INDIVIDUAL WHEELS & TIRES
 - OR -
 COMPLETE SETS AS LISTED

Exclusively at Polaris Authorized Dealers

KNOW YOUR TERRAIN



• Tread patterns optimized for extreme traction
 • Ideal for both hard pack & loose trail



• Extra deep treads
 • Self-cleaning lugs



• Triple-belted sidewalls to resist puncture
 • Purpose-built, long lasting tread patterns



• Handles extreme cold
 • Holds shape & provides traction

WHEEL & TIRE SETS

14" 40-SERIES	TRAIL				MUD	UTILITY	SNOW	
	TREKKER 27"	X TERRAIN 27"	ATTACK 26"	DUAL-THREAT 26"	MUD XC 27"	PRESERVE 27"	HARVESTER 27"	WHITEOUT 27"
4101 ○ MATTE BLACK								2882382
4201 ○ ACCENT		2889966	2882390	2883138	2884272	2883208	2882388	
4201 ○ MATTE BLACK		2889967	2882391	2883139	2884273	2883209	2882389	
4202 ○ ACCENT	2890907	2889968	2881335	2883140	2884267		2882383	
4202 ○ MATTE BLACK	2890905	2889969	2881336	2883141	2884268	2883204	2882384	
4203 BEADLOCK ○ MATTE BLACK BEADLOCKS SOLD SEPARATELY		2889972	2881381					
4204 ○ ACCENT		2889973	2881347	2883142	2884270	2883205	2882385	
4204 ○ MATTE BLACK		2889974	2881348	2883143	2884271		2882386	
4205 ○ LUSTER			2881359	2883144				
4205 ○ MATTE BLACK		2889975	2881360	2883145	2884269	2883207	2882387	
4206 ○ MATTE BLACK			2881404					
4301 BEADLOCK ACCENT BEADLOCKS PRE-MOUNTED		2889970		2883217				
4301 BEADLOCK MATTE BLACK BEADLOCKS PRE-MOUNTED		2889971		2883216				

LUG NUTS

○ Lug Nuts Required



METRIC LUG NUTS FOR ALUMINUM RIMS

» SET OF 4 • 2877385
 » SET OF 16 • 2877384
 SPORTSMAN XP

SAE LUG NUTS FOR ALUMINUM RIMS

» SET OF 4 • 2876754
 » SET OF 16 • 2877409
 SPORTSMAN 450/570

COLBY VALVE SHORT ULTIMATE VALVE - 2 PACK

» 2883292

COLBY VALVE EMERGENCY VALVE - 2 PACK

» 2883293

COLBY COMBO VALVE KIT - 16 PACK

• Includes eight Ultimate Valves and eight Emergency Valves
 » 2883294
 ORDERABLE THROUGH LOCAL DEALER ONLY



TIRE SEALANT

» 946 ML • 2830484
 » 3.8 LITER • 2830485
 » 19 LITER • 2830486
 » 19 LITER PUMP • 2830487

P. 60

KNOW YOUR WHEELS

STEP 1: SELECT YOUR SERIES

4 = 40-SERIES

STEP 2: CHOOSE YOUR LOAD RATING

1 = <362.9 kg 2 = 363 - 589.7 kg 3 = 590 - 726+ kg

STEP 3: PICK YOUR STYLE

OFFSET / BEADLOCK / COLOR

INCREASE OFFSET FROM STOCK = NARROWER STANCE
 DECREASE OFFSET FROM STOCK = WIDER STANCE

TIRE SEALANT

24 X 7 COVERAGE | BE PREPARED FOR ANYTHING

HOW IT WORKS

- 1 Tire sealant remains liquefied inside the tire until a leak develops in the tire or wheel.
- 2 Once a leak occurs, the tire sealant rushes out of the tire and quickly creates a permanent solid plug, maintaining tire pressure so you can continue your ride.



HOW MUCH DO YOU NEED?

$$\text{TIRE HEIGHT (IN.)} \times \text{TIRE WIDTH (IN.)} / 5 = \text{LITERS REQUIRED PER TIRE}$$

PREMIUM TIRE SEALANT

- Instantly seals and repairs rim, bead leaks and punctures up to 0.64 cm on standard tires and 1.9 cm on heavy ply tires
 - Helps seal the tire bead against the wheel
 - Creates permanent repair, helps maintain air pressure for the life of the tire
 - 100% water soluble for easy cleanup
 - Remains fluid and effective in temperatures down to -43° C
 - Will not rust, corrode or pit wheels
 - Easily installed through existing tire valve stem with valve core removed
- » 946 ML • 2830484
» 3.8 L • 2830485
- » 19 L • 2830486
» 19 L PUMP • 2830487
- » 208 L • 2830489
» 1041 L • 2830488

TRAILERING

RAMPS



CALIBER RAMP PRO

- Designed for ATVs and UTVs up to 127 cm wide
 - Integrated grip glides for ultimate traction
 - Folding sides for easy transportation and storing
- » 132 CM x 229 CM • 2884576



ALUMINUM ARCHED LOADING RAMPS

- Capacity for up to 1,361 kg
- » 193 CM x 30.5 CM • 907 KG • 2875384
» 224 CM x 30.5 CM • 1,361 KG • 2875386



LIGHTWEIGHT TRI-FOLD RAMPS

- Ramp folds up for transport
 - Capacity for up to 680.7 kg
 - Safety straps included
- » 183 CM x 130 CM • 2875385
» 208 CM x 130 CM • 2875860



FOLDING ALUMINUM ARCHED RAMPS

- Ramp folds up for transport
 - Up to 680 kg total capacity, 340 kg per individual ramp
 - Safety straps included
- » 224 CM x 30.5 CM • 2875387

COVERS

TRAILERABLE COVER

- » 2876614
SPORTSMAN 450/570,
SPORTSMAN 850/1000
REPLACEMENT STRAP 2871912
- » 2877999 (SHOWN)
ALL SPORTSMAN TOURING
REPLACEMENT STRAP 2871912



CV BOOT REPAIR KIT*

FIX ON THE GO | TEMPORARY COVERAGE

- A quick trail-side fix to increase trail time
- The flexible and durable boot material expands over a cone tool for CV boot repairs, without disassembling CV axles
- Universal fit – works as a temporary fix for most powersports axles
- All components fit inside the cone, and a cover is provided for compact durable storage
- Easily fits in a cargo box, attached to the roll cage, in the glovebox or many other storage locations



Items shown are contained inside cone

ATV CV BOOT REPAIR KIT

- Kit includes the following items:
- (1) Expandable CV Boot
 - (1) Reusable Cone Tool
 - (2) CV Boot Clamps
 - (1) Tube of Silicone Lube
 - (1) Grease Packet
 - (1) Cone Cover
- » 2830528

ATV TRAIL BOOT ONLY

» 2830529

UTV

- » CV REPAIR KIT 2830526
- » TRAIL BOOT ONLY 2830527

HOW TO INSTALL

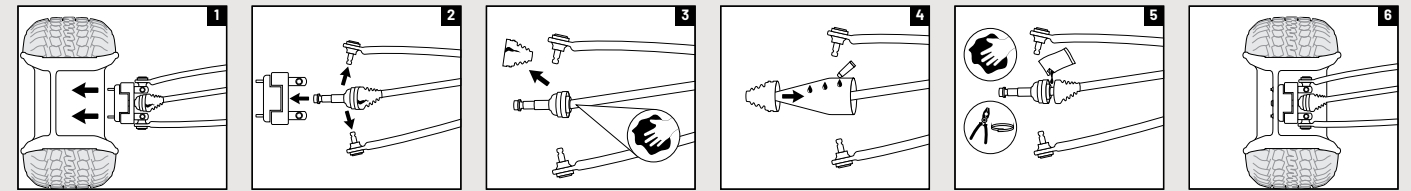

- 1 Remove wheel and axle nut.
- 2 Remove brake caliper, hub, tie rod and upper and lower ball joints.
- 3 Remove old boot and clean joint.
- 4 Spread silicone lube on entire cone tool. Slide boot over cone tool, large end first. See package for outer boot instructions.
- 5 Empty the bag of grease into the CV joint/boot, clean sealing points and install clamps.
- 6 Reassemble tie rod, ball joints, brake caliper, axle nut, tire and wheel.

Refer to your service manual for further instructions and torque specifications.
*Designed for temporary CV boot repair. Purchase the OEM CV Boot for a permanent repair.

HITCHES



HITCH WITH 5 CM BALL

- 3:1 Hitch: ball, hook and pin design
 - Rust resistant steel with powdercoat finish
 - Removable ball, HD 1.6 cm pin and clip
- » 5 CM x 5 CM RECEIVER • 2830522
» 3 CM x 3 CM RECEIVER • 2830523



4.8 CM BALL

- 4.8 cm replacement ball for hitch
 - Designed to work with 3:1 Hitch
- » 2830524



RECEIVER HITCH

- » 5 CM RECEIVER TONGUE 2875320



TRAILER BALL 1.9 CM SHANK

- » 4.8 CM BALL • 2877602
- » 5 CM BALL • 2877603

STRAPS & ROPES



RECOVERY STRAP

- 5 cm x 9.1 m
 - 8,165 kg maximum load, 4,082 kg maximum vehicle weight
 - Comes with carry bag
- » 2884033



RATCHET STRAP

- 3.8 cm x 4.6 m straps, 2 pack
 - Heavy duty webbing
 - 2,495 kg maximum load, 831 kg working load
- » 2884031



RATCHET STRAP

- 5 cm x 6.1 m
 - Heavy duty webbing, floating D-rings, double J-hooks
 - 4,536 kg maximum load, 1,497 kg working load
- » 2884032



SHOCK STRAPS

- 3.8 cm 1,361 kg breaking strength
 - Keeps tension on tie-down straps to secure load, 2 pack
- » 3.8 CM x 4.6 M • 2883296
» 3.8 CM x 2.1 M • 2883295

ACCESSORIES

450 / 570

850 / XP1000

SPRANGLER 850 / XP1000 S

MISCELLANEOUS & YOUTH

WINCHES, PLOWS & TRACKS

LIGHTING

CONNECTED TECHNOLOGY

HUNT & COOLERS

WHEELS & TIRES & TRAILERING



MAINTENANCE & GARAGE
OIL & LUBRICANTS
GARAGE ACCESSORIES
BATTERY CHARGERS & SERVICE PARTS
POLARIS POWER



MAINTENANCE & GARAGE

FACTORY APPROVED. Every Polaris vehicle has been engineered and manufactured to deliver performance. Keep it that way by using the same lubricants, cleaners and service parts our factory-trained technicians use.

OIL & LUBRICANTS

Our PS-4 engine oils provide ultimate performance and protection, they're formulated with exclusive additives to keep engines clean from deposit buildup. These powersports-grade full synthetic oils helps maximize power and protect your engine for the long term.

PS-4 FORMULATIONS BEST PROTECTION, BEST PERFORMANCE



PS-4 5W-50 FULL-SYNTHETIC OIL

Optimal for ambient operating temperatures of -40° C to 38° C.

.95 L 2876244	3.8 L 2876245	60.6 L 2876247	208 L Drum 2876246	1249 L Tote 2878814
------------------	------------------	-------------------	-----------------------	------------------------

PS-4 0W-50 EXTREME FULL-SYNTHETIC OIL

Optimal for ambient operating temperatures of -43° C to 54° C.

.95 L 2889395	3.8 L 2889396	60.6 L 2889397	208 L Drum 2889398	1,249 L Tote 2889399
------------------	------------------	-------------------	-----------------------	-------------------------



PS-4 EXTREME SYNTHETIC 0W-50

- Our best extreme high and low temp formula, excellent for high temperatures and racing, even at temps of 54°C, plus easier cold starting even below -42°C
- Expect the best in wear protection thanks to premium PAO and ester base stocks combined with a balance of moly and ZDDP additives
- Polaris exclusive clean engine additive system reduces deposits and carbon build-up for peak performance and power

THE BEST PROTECTION, MAXIMUM PERFORMANCE

- Powersports grade full synthetics provide long lasting engine protection
- At least 40% improved wear protection compared to all aftermarket oils tested (see engine wear test chart)
- Polaris exclusive clean additive system
- At least 50% less deposits than all aftermarket oils tested (see deposit test chart)
- Cleaner engine with less deposits means consistent maximum power and performance

WIDEST VISCOSITY FOR ULTIMATE PROTECTION



ENGINE WEAR TEST

LOWER NUMBER = LESS ENGINE COMPONENT WEAR
LESS WEAR ON PARTS MEANS LONGER ENGINE LIFE

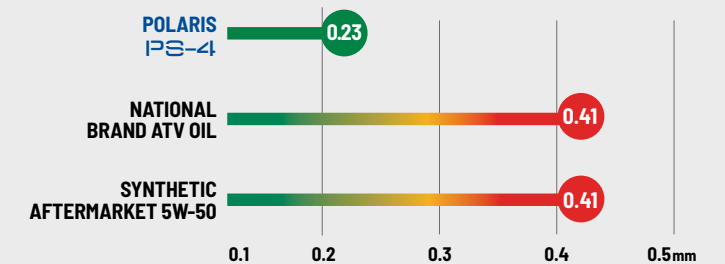

ASTM D4172. In 3rd party testing against 9 competitive products Polaris had 40% or better wear protection compared to all of the tested products. Numbers represent mm of wear scarring measured. Test measures wear at contact points, wear scar is measured for its length and width (in units of mm). Lower wear numbers mean better wear protection and friction reduction.

DEPOSIT TEST

LOWER DEPOSITS = MAXIMUM POWER

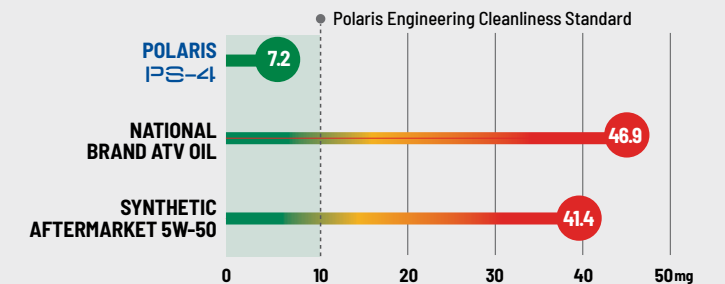

ASTM D6335. In 3rd party testing against 9 competitive products Polaris PS-4 had less than half the deposits compared to the next closest product. No other tested products met Polaris Engineering standards for deposit cleanliness. Test measures mass of deposits in mg in high temp, high stress test cycles. Higher deposits will impact engine power and performance.

OIL CHANGE KITS

These convenient kits include everything needed including filter and oil volume per vehicle

PART NUMBER	VEHICLE FITMENT	PART NUMBER
2890882	RANGER XD 1500	2890883
2202166	RANGER/RZR/SPORTSMAN 570, TWIN 600, TWIN 700, TWIN 800	2890056
2879323	RANGER, GENERAL 900-1000, RZR 900-1000, RS1, POLARIS XPEDITION	2890057
2877473	RANGER/SPORTSMAN 300-500, SPORTSMAN/SCRAMBLER 500/850/1000	2890055
2881696	RZR TURBO (NON PRO R)	2890058
2890880	RZR PRO R	2890881

POLARIS INVESTS IN EACH OIL AT & ABOVE THESE LEVELS

**12+ DEDICATED
TEAM MEMBERS**
FOCUSED ON POLARIS OIL

18+ MONTHS
DEVELOPMENT & TESTING

76,000+ HOURS
DYNO TESTING

3.5 MILLION+ KILOMETERS
FIELD TESTING



DOT 4 BRAKE FLUID

A high-quality brake fluid designed for use in Polaris hydraulic brakes.
» 355 ML • 2872189



SUSPENSION/ U-JOINT GREASE

» 89 ML • 2871515
» 414 ML • 2871551



GAS SHOCK OIL

» .95 L RACING • 2874124
WALKER EVANS RACING REBUILDABLE SHOCKS
» .95 L PREMIUM • 2870995
FOX REBUILDABLE SHOCKS



AGL

Protects transmission components against wear, corrosion, oxidation and foam in transmissions.
» .95 L • 2878068
» 3.8 L • 2878069
» EXTREME • .95 L • 2891028



DEMAND DRIVE FLUID

Proprietary formulation prevents clutch slippage and chatter and reduces component wear and corrosion.
» .95 L • 2877922
» 9.5 L • 2877923



ANTI-FREEZE

Prevent corrosion on metal components, eliminate scaling and maximize cooling system performance.
» .95 L • 2880514
» 3.8 L • 2880513
» 208 L • 2880512



CARBON CLEAN

Ultimate fuel and injection system cleaner.
» 355 ML • 2881413



ADVANCED FUEL TREATMENT

Dual antioxidant formula protects jets and fuel system from gum and varnish.
» 355 ML • 2881416

GARAGE ACCESSORIES



NEW PARTS TRAY CABINET

- Roller bearing design
- 20.5" W x 16.75" D x 14.75" H
- » PARTS TRAY CABINET W/ 4 DRAWERS • 2830605
- » SQUARE DIVIDERS (24 COMPARTMENTS) • 2830606
- » ADJUSTABLE DIVIDER • 2830607
- » CABINET STAND • 2830608
- » CABINET WITHOUT DRAWERS • 2830609



NEW EXTENSION CORDS

- Light-up cords designed for extreme cold and heat
- » HD XD 15.2M TRIPLE OUTLET 1 $\frac{1}{2}$ " • 2830587
- » 7.6M SINGLE OUTLET 1 $\frac{1}{2}$ " • 2830588
- » 15.2M SINGLE OUTLET 1 $\frac{1}{2}$ " • 2830589
- » .6M TRIPLE END 1 $\frac{1}{2}$ " • 2830603
- » .6M ADAPTER 30A TO 20A 1 $\frac{1}{2}$ " • 2830602



BATTERY OPERATED FLUID TRANSFER PUMP WITH FLOW CONTROL NOZZLE

- Ideal for quick transfer of fluid, diesel, DEF/Adblue, water & water-based media
- Handheld flow control nozzle
- Powered by two 'D' batteries (not included)
- » 2830595



HANDHELD PUMP SPRAYER

- Half gallon portable sprayer
- Lightweight and easy to use
- » 2830570



OIL CHANGE KIT

- 6.5 QT drain pan, one pint oil funnel with screen, oil filter wrench, 15" x 18" absorbent pads (2), clean up wipe (1), 6 mil nitrile gloves (1 pair), blue interfold shop towels (4)
- » 2830545



OIL FILTER WRENCH - 65MM (2 $\frac{9}{16}$ ")

- 14 flute cup size - used with $\frac{3}{8}$ " square drive
- Works with Polaris Oil Filters 2540086, 2520799 and other 14 flute filters
- » 2830550



PREMIUM MAINTENANCE TOOL KIT

- Includes 51 pieces
- » 2830565



POLARIS HEAVY-DUTY SCRUBBER WIPES

- » 90 CT • 2830441



POLARIS SHOP TOWELS

- » 200 CT W/ DISPENSER • 2830402
- » 200 CT REFILL • 2830403
- » 64 CT REFILL • 2830440



BATTERY OPERATED FLUID TRANSFER PUMP

- Liquid transfer pumps 5-6 quarts/min suctioning power
- Powered by two 'D' batteries (not included)
- » 2830513



FLEXIBLE CLUTCH COVER TOOL

- Set includes:
- (1) $\frac{1}{4}$ " drive x 11" flexible driver
- (1) $\frac{1}{4}$ " Drive double sided socket - $\frac{1}{2}$ " x 8mm
- Rubber grip handle and flexible shaft for better leverage
- » 2830572



FLEX SPOUT

- Fits all Polaris quart, gallon and 2.5 gallon bottles
- » 2871285



POLARIS LED POCKET FLASHLIGHT

- Powerful beam - extends 200'
- Powered by 2 AAA batteries
- 90 lumens, 1 watt, energy efficient light
- » 2830436



POLARIS MAGNETIC PARTS TRAY

- » 2830432



POLARIS 8.4 cm TELESCOPIC MAGNET

- Retrieve fasteners or parts dropped in hard-to-reach places
- 5 LBS of holding strength
- Extends from 6.5" to 33"
- » 2830435



FLUID FUNNEL

- Narrow spout for controlled pouring
- Designed to prevent overfills
- Durable for all types of chemical exposure
- » 2830552



FLUID SYRINGE

- Easily add and remove fluid from your vehicle
- » 2830553



FLUID CHANGE TRAY

- 22" x 22" x 11.5"
- Chemical and heat resistant
- Holds up to 2 gallons of liquid
- » 2830551



PUMP

- Fits 1 and 2.5 gallon bottles
- » 2870465



TRAIL TECH PORTABLE AIR COMPRESSOR

- Handheld air compressor with Li-ion battery
- Programmable PSI pressure settings, LED light and USB phone charger
- » COMPRESSOR • 060-DAP
- » CASE • 060-BAG
- » 15" EXTENDER HOSE • 060-LHS



FOLDING WORK LIGHT - 2000 LUMENS

- Rechargeable light with 2 LED light heads and 360° magnetic swivel handle that functions as a stand
- » 2830591



FUNNELS

- Narrow spout for controlled pouring
- Designed to prevent overfills
- Durable for all types of chemical exposure
- » 1.2 L BLUE • 2830574
- » 1.4 L RED • 2830575
- » 1.4 L GREEN • 2830576



GREASE GUN

- For 414 ML All-Season & U-Joint
- Heavy-duty, one-handed pistol grip
- 5,000 PSI, with a 4" steel extension efficiently lubricates, reduces friction and wear and tear
- » 414 ml • 2830569



GREASE GUN

- For 88.7 ML All-Season & U-Joint
- Tough steel construction
- Accepts both 8" rigid pip nozzle and 12" 12,000 PSI flex hose
- Enables easy application of grease
- » 88.7 ml • 2871312



WORK LIGHT - 550 LUMENS

- UV and dual-charging on a 360° rotating swivel
- » 2830584



WORK LIGHT - 1000 LUMENS

- Adjustable with magnetic ends
- Battery charge indicator
- » 2830585



WORK LIGHT - 4000 LUMENS

- 90° swivel LED light with magnetic backing
- 16', 14 gauge extension cord cable reel
- » 2830586

BATTERY CHARGERS



SERVICE PARTS

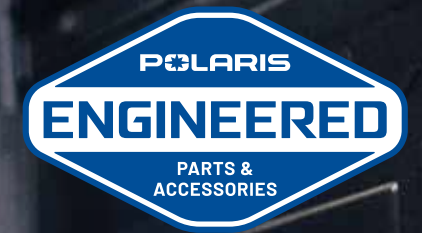

POLARIS ENGINEERED SERVICE PARTS DELIVER UNMATCHED PERFORMANCE AND FIT FOR YOUR OFF-ROAD VEHICLE.

All service parts are engineered specifically for your machine. Which means everything is designed, tested and perfected to maximize the life of your ride. Getting Polaris Engineered parts is a decision that pays off in the long run, because there is a long run.

VISIT YOUR POLARIS DEALER TO SHOP FOR SERVICE PARTS.



NOCO GENIUS® BATTERY CHARGER - 1 AMP

- Keep your battery charged
 - Includes Boost Eyelet Cable with X-Connector Adaptor (2830546)
 - Includes adaptor for vehicle charge port
- » 2830567



NOCO GENIUS® BATTERY CHARGER - 2 AMP

- Keep your battery charged
 - Includes Boost Eyelet Cable with X-Connector Adaptor (2830546)
 - Includes adaptor for vehicle charge port
- » 2830568



NOCO GENIUS® BATTERY CHARGER - 5 AMP, 2 BANK

- Waterproof charger
 - 5 amps per bank for charging any 12v, AGM, lead-acid and/or lithium-ion batteries
- » 2830599



NOCO GENIUS® BATTERY CHARGER - 10 AMP, 4 BANK

- Waterproof charger
 - 10 amps per bank for charging any 12v, AGM, lead-acid and/or lithium-ion batteries
- » 2830601



NOCO BOOST® GB40 12V 1000A JUMP STARTER

- Delivers 1,000 amps for jump starting a dead battery in seconds
- » 2830547



NOCO BOOST® GB70 12V 2000A JUMP STARTER

- Delivers 2,000 amps for jump starting a dead battery in seconds
- » 2830597



NOCO BOOST® JUMP PACK PROTECTION CASES

- Lightweight, durable and rugged custom exterior
- » GB40 • 2830548
» GB70 • 2830598

YOUR BATTERY IS READY WHEN YOU ARE

FOR THE LIFE OF YOUR RIDE

Maintenance is the key to keeping your Polaris off-road vehicle performing at its peak. Items like belts, lubricants, and batteries represent only a few of these critical items engineered specifically by Polaris.



TESTED, PERFECTED

We test each belt on the intended vehicle - we don't just try to make an existing belt "just work".

- Amery, Polaris System Engineer

POLARIS ENGINEERED DRIVE BELTS

OUR INVESTMENT

- 32,187 km of field testing
- Thousands of dyno hours
- 18+ months of development (3,000+ design hours) per belt
- 1,200+ vehicle validation hours
- Collaboration with powertrain & clutch engineers

YOUR ADVANTAGE

- No clutch recalibration
- Less wear & tear due to heat
- Ensure maximum performance of your vehicle
- More time out riding, less time wrenching

OUR INVESTMENTS ENSURE POLARIS BELTS OUTPERFORM YOUR EXPECTATIONS.



TRY THE POLARIS MOBILE APP

COMPATIBLE WITH P2500iEBT & P3200iEBT

- Start & Stop Generator
- Monitor Fuel Level (with Low Fuel Warning), Output Percentage, Total Hours, Power Output
- Monitor Total Run Time Remaining, AC Wattage, AC Voltage, Engine, RPM & Engine Temperature
- Access Service & Owners Manual

P2000i Inverter Generator 2830532



BEST USED FOR

- Tailgating
- Off-Grid
- Camping



Extension Cord Management

P2500iEBT Inverter Generator 2830537



BEST USED FOR

- Tailgating
- Off-Grid
- Camping



Polaris Mobile/App Compatible for Digital Gauge Readings and Remote Start Features

NEW P3200iEBT Inverter Generator 2830539



BEST USED FOR

- DIY Remodeling
- One Room Backup
- RV'ing

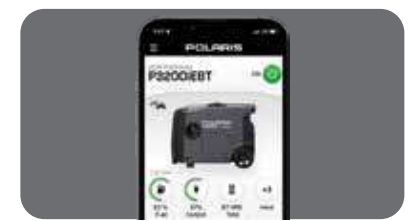

Polaris Mobile/App Compatible for Digital Gauge Readings and Remote Start Features

P5500 / P6500 Open Frame Generator 2830534 / 2830535



BEST USED FOR

- Construction
- Home Backup
- RV'ing



Rough Terrain Wheel

Electric Start

PRESSURE WASHER 3700 2830573



- 3700 psi at 2.5 gpm
- Simpson pro-axial cam pump
- CRX 4-stroke 225cc OHV engine
- Low oil shut-down system
- 10" pneumatic tires
- Heavy-duty steel engine plate
- 1.25" tubular construction
- Professional spray gun
- 35' Morflex® hose
- Thermal relief valve

ELECTRIC PRESSURE WASHER 2500 2830592



- 2500 psi at 1.5 gpm
- 120v electric induction motor
- Axial pump with thermal relief valve
- Detachable cart for easy transport
- Professional spray gun with quick connect nozzles
- 25' Morflex® hose
- 8" Never-flat tires

FEATURED ACCESSORIES



SMALL ENGINE OIL
• 4-cycle engine oil
» 2879383



ALL WEATHER COVER
» P2500iEBT • 2830540
» P3200iEBT • 2830541
» P5500/P6500 • 2830542



HIGH ALTITUDE MODIFICATION KIT
» P2500iEBT • 2889540
» P3200iEBT • 2884866



INVERTER PARALLEL KIT
• Parallel to any two Polaris inverter generators
» 2830536



BATTERY OPERATED FLUID TRANSFER PUMP WITH FLOW CONTROL NOZZLE
» 2830595



TURBO NOZZLE
• 3700 PSI .25" QC turbo nozzle delivers a strong jet of oscillating water that cleans faster than standard nozzles
• Made for reliability and durability, this nozzle is easy to use and great at cleaning hard to remove dirt and debris
» 2830579

Read, understand and follow your owner's manual. Never operate a generator indoors. Generator exhaust contains carbon monoxide vapors and exposure can result in severe injury or death. Gasoline is highly flammable and explosive under certain conditions. Always use extreme care whenever handling gasoline.



APPAREL

FIT FOR ANY ADVENTURE. For outdoor enthusiasts looking for gear that's purposefully built to stand up to the fun and challenging experiences Polaris vehicles enable. Each piece of apparel and equipment bearing the name Polaris is crafted by outdoor enthusiasts, for outdoor enthusiasts. They are a badge of honor – representing what the Polaris brand stands for – a passion to simply be outside doing what you love.

JERSEYS, GLOVES & GAITERS



WHITE/BLUE Adult 2865376	TAN/ORANGE Adult 2865377 Youth 2865382	FUCHSIA/GRAY Adult 2865379 Youth 2865381	TEAL/LIME Adult 2865378	BLACK Adult 2865374	BLUE Adult 2865375 Youth 2865380
--------------------------------------	---	---	-------------------------------------	---------------------------------	---

NEW
THROTTLE JERSEYS

ADULT: S-3XL
YOUTH: S-XL

- Mesh ventilated panels for maximum airflow
- Elastic sleeves with non-restrictive cuffs



WHITE/BLUE Adult 2865385	TAN/ORANGE Adult 2865386 Youth 2865391	FUCHSIA/GRAY Adult 2865388 Youth 2865390	TEAL/LIME Adult 2865387	BLACK Adult 2865383	BLUE Adult 2865384 Youth 2865389
--------------------------------------	---	---	-------------------------------------	---------------------------------	---

NEW
THROTTLE GLOVES

ADULT: S-3XL
YOUTH: S-XL

- Adjustable wrist closure for a custom fit
- Silicon finger grips and neoprene knuckle protection



BLUE 2833138	LIME 2861952	CAMO 2861948	BLACK 2861953	RED RETRO 2861950
------------------------	------------------------	------------------------	-------------------------	-----------------------------

NECK GAITERS

- Keep the sun off your neck and the dust off your face
- Stretchy and seamless material
- UPF 15-18 for sun protection and moisture-wicking

RANGE COLLECTION



NEW
RANGE WORK JACKET

Rugged and warm jacket that's tough for work and comfortable for play

MEN'S | S-3XL
Black | 2865321
Tan | 2865322

WOMEN'S | S-3XL
Black | 2865345
Tan | 2865346



RANGE WORK GLOVE

MEN'S | S-3XL
Black | 2865392

CASUALWEAR & HATS



NEW
SOFTSHELL JACKET 2.0

MEN'S | S-3XL
Black | 2865318
Rust | 2865319
Blue | 2865320

WOMEN'S | S-3XL
Black | 2865343
Blue | 2865344



PURSUIT HOODIE

MEN'S | S-3XL
Orange | 2864606
Camo | 2862494
Black | 2833076
Green | 2833077

WOMEN'S | S-3XL
NEW Camo | 2865488



UPF HOODIE TEE **TOP SELLER**

MEN'S | S-3XL
NEW Olive | 2865492
Blue | 2833072
Gray | 2833073

WOMEN'S | S-3XL
NEW Navy | 2865494
Pink | 2833102
Teal | 2833103



PLAID FLANNEL SHIRT

MEN'S | S-3XL
NEW Cabernet | 2865495
Blue | 2864671
Cypress | 2864672

WOMEN'S | S-3XL
NEW Cabernet | 2865496
Blue | 2864673
Teal | 2864674



NEW
PERFORMANCE SHIRT

MEN'S | S-3XL
Sand | 2865497
Cypress | 2865498



PIT SHIRT **TOP SELLER**

MEN'S | SIZE VARIES
Cypress | S-3XL | 2864561
Black | XS-4XL | 2862526
Navy | S-3XL | 2833043



ELLIPSE PATCH TRUCKER HAT

Purple | 2864563
Cypress | 2864562
Gray | 2833498

Black | 2833500
Navy | 2833499
Orange | 2833124



CORE CAP **TOP SELLER**

Red | 2833123
Gray | 2833507
Navy | 2833494
Black | 2833495



SHIELD PATCH CAP

Navy | 2864578
Red | 2864579



STAPLE CAP **TOP SELLER**

NEW Maroon | 2865516
Cypress | 2864568
Black | 2833127
Navy | 2833128



STEALTH CAMO CAP

Camo | 2861527



HUNTER ORANGE HAT

S/M | 2860892
L/XL | 2862545



TONAL HAT

Orange | 2864564
Black/Red | 2833497
Navy | 2833496



CORE BEANIE

Orange | 2862595

HELMETS & GOGGLES



TEAL/LIME
2865411

NEW
509 TACTICAL 3.0 MTN

EXPERIENCE TOP-TIER PROTECTION,
COMFORT AND CONNECTIVITY

XS-4XL
SIZE VARIES BY COLOR
ALSO AVAILABLE IN YOUTH

SHELL

• Poly and ABS polymer construction - ensures both strength and a lightweight feel for maximum protection

WEIGHT

• Starting at 1,300g

FEATURES

- Venturi Vent system generates negative pressure at velocity and pulls moist air from the breath box
- Cardo UCS Compatibility - integration and easy assembly of Cardo UCS modules (sold separately)
- Magnetic Fidlock chin-strap technology
- Plush liner design
- Compatible with VEES Protection System (sold separately) for cold days
- DOT-and ECE 22.06-approved



FULL DETAILS ONLINE



NEW
MAROON/FUCHSIA
2865435

TENACITY 4.0

COMBINATION OF MODERN STYLE & PREMIUM PROTECTION WITH INCREDIBLE VALUE

XS-2XL

SHELL

• Shock-resistant, injection-molded thermoplastic

WEIGHT

• 1,500g

FEATURES

- Through-flow, full-helmet ventilation
- ProClip quick release chin strap allows you to fasten the chin strap in seconds
- Removable breath box
- Toolless adjustable roost shield
- Removable, washable liner
- DOT- and ECE 22.06-approved



FULL DETAILS ONLINE



NEW
FUCHSIA/GRAY
2865427

509 KINGPIN

PREMIUM MATERIALS, ATTRACTIVE PRICE

FEATURES

- Built for off-road, the oversized spherical lens delivers optimal peripheral vision
- Metal tear-off posts provide strength and durability
- Quick-change technology allows you to run the best lens tint for conditions



FULL DETAILS ONLINE



NEW
BLUE
2865431

509 MX6

SUPER WIDE FIELD OF VIEW, ENGINEERED FOR DIRT

FEATURES

- PC outer lens with anti-scratch coating, and internal anti-fog coating
- Outriggers with latch system for quick lens change
- 45mm strap with silicone to hold strap in place



FULL DETAILS ONLINE

HOME & COLLECTIBLES



KICKBACK
ROCKER
Green | 2864816
Blue | 2862626



HITCH
COVER
2861623



POLARIS
KEY RACK
30.5 cm x 20
cm | 2864718



15 OZ
CAMPFIRE
MUG
2861613

FORGE YOUR OWN PATH



POLARIS
Think Outside

Availability varies by market, check your local dealer for availability. Never transport a loaded firearm. Verify firearm is unloaded prior to mounting. Please refer to local laws and regulations regarding the requirements for the legal transport of firearms.

Warning: Polaris Off Road vehicles can be hazardous to operate and are not designed for on-road use. Driver must be at least 16 years old with a valid driver's license to operate. All riders should always wear helmets, eye protection and protective clothing and footwear. Read, understand and follow your owner's manual. Ride within the limits of your own abilities and never engage in stunt or exhibition driving. Never ride under the influence of drugs or alcohol. All riders should take a safety training course.

Unless noted, trademarks are the property of Polaris Industries Inc. 509® is a registered trademark of Teton Outfitters, LLC. App Store® is a registered trademark of Apple Inc. Bluetooth® is a registered trademark of Bluetooth Sig, Inc. Caliber® is a registered trademark of Caliber, Inc. Cardo® is a registered trademark of Cardo Systems, Inc. Facebook™ is a service trademark of Facebook, Inc. Fidlock® is a registered trademark of Fidlock GmbH. FOX® is a registered trademark of Fox Factory Inc. Google Play™ is a service trademark of Google LLC; and YouTube™ is a registered trademark of Google LLC. GoPro® is a registered trademark of GoPro Inc. Instagram™ is a service trademark of Instagram, LLC. MORFLEX® is a registered trademark of FNA Group, Inc. NOCO Genius® and NOCO Boost® are registered trademarks of The Noco Company. OGIO® is a registered trademark of OGIO International, Inc. RHINO-RACK® is a registered trademark of Rhino Rack Australia Pty Limited. RIGID® is a trademark of JST Performance, LLC d/b/a Rigid Industries, LLC. Rockford Fosgate® is a registered trademark of Rockford Corporation. SMART BOARD® is a registered trademark of Smart Technologies ULC Unlimited Liability Corporation Canada. Tiger Drylac® is a registered trademark of Tiger Coatings GmbH & CO. KG. Velcro® is a registered trademark of VELCRO IP HOLDINGS LLC. Twitter™ is a service trademark of X CORP. Fitment and availability are subject to change at any moment. Copyright © 2024 Polaris Industries Inc. All rights reserved.